HP 16600A and 16700A Series Logic Analysis System Mainframes

Product Overview

Solutions for Digital System Debug

The Advantage of Insight

Debugging today's digital systems is tougher than ever. Increased product requirements, complex software, and new innovative hardware technologies all need to come together in a shorter amount of time to meet your time-to-market goals.

When the prototype does not work as expected or needs tuning to meet performance requirements, you need test equipment that quickly provides reliable insight into your toughest problems. You want the answer to the problem, and you want it right away.

This is why HP has introduced a suite of logic analysis, emulation, and software tools to give you the insight you need. Whether you are

a hardware or software designer, HP has tools that address your debugging and verification needs.

The HP 16600A and 16700A Series logic analysis systems assist you in completing digital system debug tasks by allowing you to examine system behavior from every angle with an intuitive multi-window interface. From controlling processor execution (run control) and viewing bus activity to taking timing measurements and verifying signal integrity, you gain insight into your tough hardware and software integration problems.

The HP 16600A Series logic analyzers offer you the best value in logic analysis and emulation. With up to 204 built-in channels of analysis, on-chip emulation capability, and one measurement module slot, the

HP 16600A Series delivers a complete digital system debug tool at a very economical price.

The HP 16700A logic analysis system is a high-performance expandable tool designed to grow with you as your needs change. The mainframe features five slots for measurement modules and two slots for emulation modules, so you can add state and timing analysis capability, pattern generation, and oscilloscope measurements in addition to on-chip emulation support for microprocessor control. The HP 16701A expansion frame combines with the HP 16700A mainframe to give you an additional five slots for measurement modules and an additional two slots for emulation modules (ten total slots for measurement modules and four total slots for emulation modules).



Figure 1. The HP 16600A and 16700A Series Logic Analysis System Mainframes

Key Features

The HP 16600A and 16700A Series logic analysis systems share an intuitive, easy-to-use multi-window interface and common capabilities.

A large display with multiple sizable windows allows you to see at a glance more of your target system's operation. Color lets you highlight critical information so you can find it quickly. X-Windows and NFS (network file system) make it easy to work remotely.

Multiple time-correlated views of data let you examine target operation from different perspectives, to confirm both signal integrity and software execution flow with one tool. This is invaluable in solving cross-domain problems.

Setup Assistant helps you get your new analyzer up and running, allowing you to make your first measurement quickly and easily.

On-chip emulation for many popular microprocessors together with links to debuggers help you bring hardware and software together into a working system more quickly than with conventional digital debug tools.

Configure a System With the Modules You Need

Most HP 16500 measurement modules are also compatible with the HP 16600 and 16700 mainframes. All mainframes support the following acquisition modules.

Oscilloscope

HP offers a 500 MHz/2 gigasample per second (GSa/s) module and a 250 MHz/1 GSa/s module. Both have two channels and a 32 K memory depth. You can use the logic analyzer to trigger the scope at the precise moment necessary to identify a possible ground bounce, metastability, or cross-talk problem.

State/Timing

HP offers a wide variety of state/timing modules to help you match your tools to your specific measurement needs. See "Supported State and Timing Modules" on page 4.

High-Speed Timing

To help you verify even the most demanding timing requirements, you can get up to 4 GSa/s for 16 channels (64 K memory) with built-in setup and hold time violation triggering.

Pattern Generation

HP's 200-Mvectors/sec, 40-channel module with 252 K of memory for stimulus can substitute for missing system components or provide a stimulus-response test environment.

Emulation

The emulation module provides a connection to a debug port (BDM or JTAG), either on your target or on an analysis probe. You access full run-control features of the module through either the graphical interface or a third-party debugger. The module's options allow you to choose the proper firmware to communicate with a specific target debug port.

Post-Processing Tool Sets Help You Integrate Hardware and Software

When you want to really understand what your target is doing and why, you need to be able to view software execution results in the context of specific hardware events. HP's optional tool sets are available to assist in the processing of captured analysis data.

Source Correlation Tool Set

You can correlate a logic analyzer trace with the source code that produced it and set up the logic analyzer trigger by simply pointing and clicking on a source line. This tool helps you debug your code when you cannot or choose not to halt the microprocessor.

System Performance Analysis Tool Set

You can profile and analyze system performance to uncover bottlenecks in the software or hardware elements within your target.

Serial Analysis Tool Set

This tool lets you acquire and analyze serial data streams to debug problems in peripheral communications.

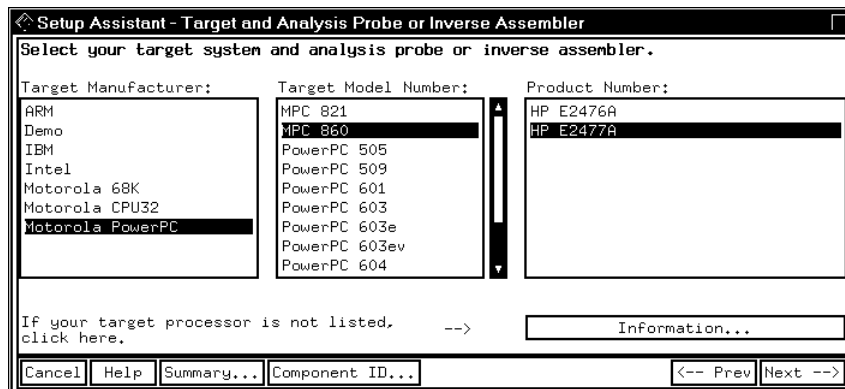

Figure 2.
Setup Assistant gets you up and running quickly.

On-Chip Emulation Tools Make Fixing Bugs Easier

For specific microprocessor families that feature on-chip emulation, you can add a processor emulation module to connect the on-board debugging resources of the microprocessor to the logic analyzer and to a high-level debugger.

Emulation Control Interface

Designed for hardware engineers, this tool set provides basic run control (run, stop, break, reset), chip register access, memory access, and the ability to download code to your target.

Integrated Debugger Support

HP offers you unprecedented visibility into software execution for systems running software written in C and C++. You can achieve the functionality of a full-featured emulator by using a third-party debugger which drives the installed HP emulation module. This gives you active and complete microprocessor run control.

Speed Problem Solving With Off-the-Shelf Solutions for Many Common Microprocessors

For microprocessors that do not support on-chip emulation, HP provides non-intrusive capture and disassembly of microprocessor and bus activity through analysis probes and inverse assembly tools.

Analysis probes are available for over 200 microprocessors and microcontrollers. Bus probes allow probing of popular bus architectures such as PCI, USB, VXI, SCSI, and many others.

Flexible physical probing schemes give you a variety of microprocessor and bus probes for quick and reliable connections to almost any device on your prototype.

Target Control and Coordinated Measurements

Both the HP 16600A and 16700A Series logic analysis systems feature built-in auxiliary control ports that help you manage your target and coordinate measurements between separate analysis frames.

You can use the target control port to activate reset or interrupt lines, making it convenient to control your target remotely. Port-in/port-out BNC connectors allow you to trigger or arm external devices or receive signals that can be used to arm acquisition modules within the logic analyzer.

Scalable Tools Outfit the Whole Team

Get the most out of your team's capital equipment budget. HP's digital system debug solutions can be scaled to meet your needs today and, with the HP 16700A, upscaled later to protect your company's future investment.

Whether you are a hardware designer, system designer, or embedded software/ firmware developer, HP has a solution to help you completely outfit your team while providing budgetary flexibility. With HP's scalable systems, you don't need to waste money on features you'll never use. And you won't be faced with scrapping recently bought tools just because you changed microprocessors. Today and tomorrow, HP is with you.

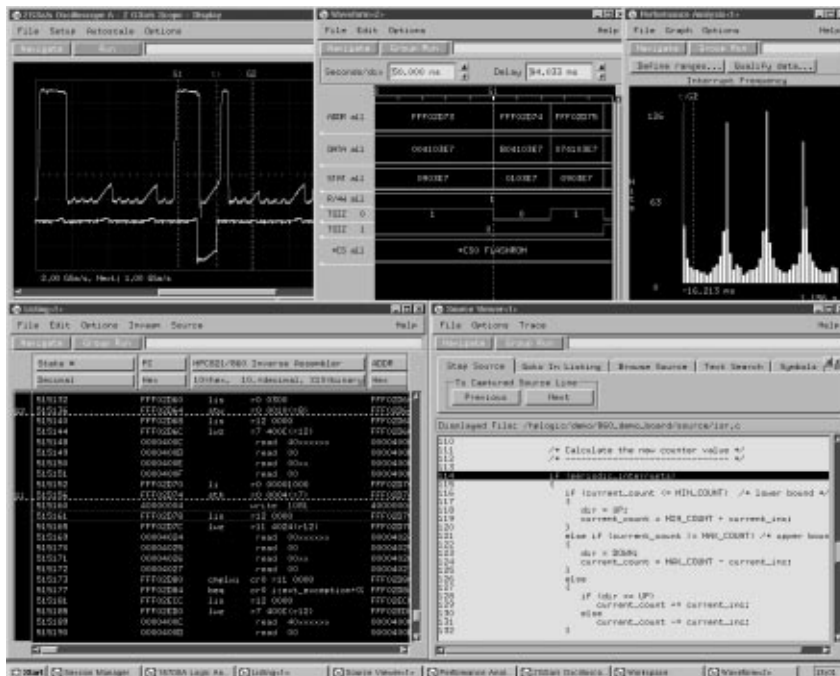

Figure 3. You can quickly isolate the root cause of system problems by examining target operation across a wide analysis domain, from signals to source code.

The HP 16600A Versus the HP 16700A Series: Which One Is for You?

The following tables outline some key differences.

Briefly, the HP 16600A Series logic analysis system offers built-in state and timing capabilities from 204 to 68 channels. These channel configurations are fixed. However, each frame contains one expansion slot for additional measurement capability, such as an oscilloscope or analysis module.

The HP 16600A Series supports advanced state and timing acquisition technology featuring Context Store. Using Context Store, you can store the events that occur

before and after a specific trigger condition in a time window centered approximately around an event. Trace memory is filled only with data that is specific to the measurement you want to make. This makes it easier to identify the cause of memory and pointer corruption problems without having to sort through large amounts of trace data.

When you make the decision to choose the HP 16700A Series platform, you have chosen a system that can change as your needs grow. You decide which general-purpose state and timing analysis modules best fit your needs, then you add analysis channels and trace memory depth according to your individual requirements.

Upgrade From Your HP 16500, HP 1660/70 or HP 64700 to the HP 16600A and 16700A

HP keeps pace with your digital debug needs while protecting your investment. You'll receive a trade-in allowance for your existing HP logic analyzer or emulator when purchasing the new HP 16600A and 16700A logic analysis systems with integrated emulation. This offer is good until March 31, 1999.

HP 16600A and 16700A Series Supported State and Timing Modules

Model	HP 16550A	HP 16555A	HP 16555D	HP 16556A	HP 16556D	HP 16517A
Maximum state clock	100 MHz	110 MHz	110 MHz	100 MHz	100 MHz	1 GSa/s
Maximum timing sampling rate	500 MHz	500 MHz	500 MHz	400 MHz	400 MHz	4 GSa/s
Memory depth (full/half channels)	4/8 K	1/2 M*	2/4 M*	1/2 M*	2/4 M*	64/128 K*
Channels/card	102	68	68	68	68	16
Maximum channels (on a single time base and trigger)	204	204	204	340	340	80
Maximum channels in a single HP 16700 mainframe	510	340	340	340	340	80
Maximum channels in an HP 16700 series system (w/ expansion mainframe)	1020	680	680	680	680	160
Number of state clocks/qualifiers	6	4	4	4	4	2
Setup/hold time	0/3.5 ns to 3.5/0 ns, adjustable in 500 ps increments					350 ps/ 350 ps

*Increased memory depth in half channel timing mode only.

Built-in Logic Analysis Capability of the HP 16600A Series Analyzers

Model	HP 16600A	HP 16601A	HP 16602A	HP 16603A
Maximum state clock	100 MHz	100 MHz	100 MHz	100 MHz
Maximum timing sampling rate (full/half channels)	125/250 MHz	125/250 MHz	125/250 MHz	125/250 MHz
Memory depth full/half channel	64/128 K	64/128 K	64/128 K	64/128 K
Channels supported	204	136	102	68
Supports Context Store	Yes	Yes	Yes	Yes
Setup/hold time	0/4.5 ns to 4.5/0 ns adjustable in 500 ps increments			

Top-Level Comparison of the HP 16700A and 16600A Series Mainframes

Mainframe	HP 16700A	HP 16600A/16601A/16602A/16603A
Slots for measurement modules	5 (10 total with HP 16701A expansion frame)	1
Built in state/timing channels	None	204, 136, 102, 68
Number of emulation module slots	2 (4 total with HP 16701A expansion frame)	1
HP 16701A expansion frame support	Yes	No

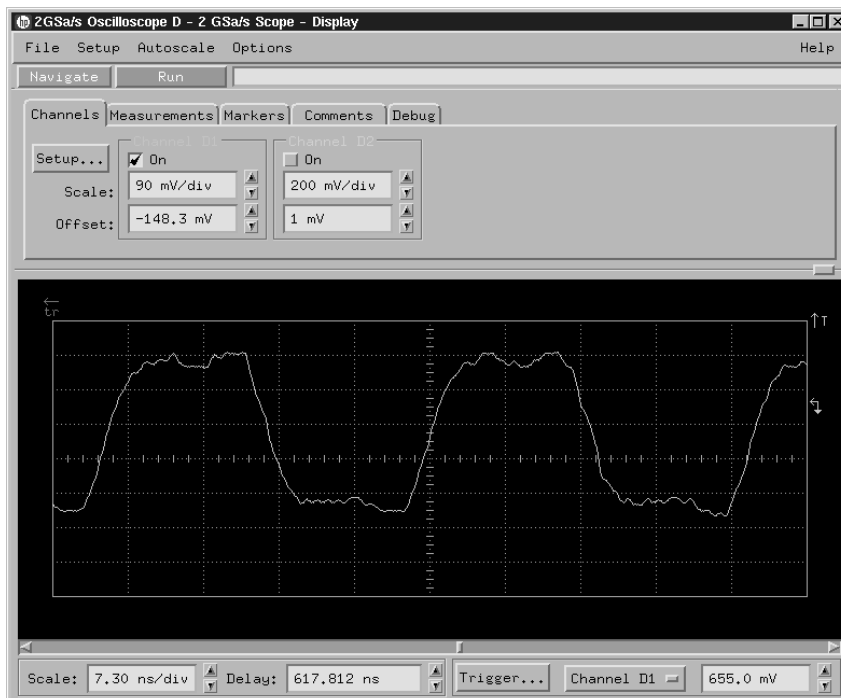

Figure 4. The HP 2 GSa/s oscilloscope helps you zero in on signal integrity issues.

Sample Configurations

The following tables provide two examples of complete logic analysis system configurations. The first configuration is for the HP 16600A and provides a complete emulation solution for the Motorola Power PC.

The second configuration is based on the HP 16700A and supports Intel Pentium® measurements.

Use these tables as samples to help you design a system to fit your specific needs.

You may wish to consult *System Configuration for the HP 16600A and 16700A Series Logic Analysis Systems*, pub. no. HP 5966-3148E, for more information.

HP 16600A Sample Configuration for the Motorola Power PC 860 Microprocessor

Product Number	Description
HP 16600A	204-channel logic analysis system with one emulation module slot and one measurement module slot
Options	
001	17-inch color monitor
003	Performance upgrade to 160 MB total RAM and 2 MB video RAM
004	External CD-ROM drive
HP E9484A option 002	Emulation solution for Motorola MPC 860 microprocessor This includes: 860 emulation module (HP E5901A option 080) BGA analysis probe for 357 pin BGA package (HP E2476A) Source correlation tool set (HP B4620B)
HP 16534A	500 MHz, 2 GSa/s oscilloscope

HP 16700A Sample Configuration for the Intel Pentium® Microprocessor

Product Number	Description
HP 16700A	Logic analysis system mainframe with 5 slots for measurements modules and 2 slots for emulation modules
Options	
001	17-inch color monitor
003	Performance upgrade to 160 MB total RAM and 2 MB video RAM
004	External CD-ROM drive
HP E9492A option 002	Emulation solution for Intel Pentium microprocessor This includes: Pentium emulation module (HP E5901A option 500) 296 pin SPGA analysis probe (HP E2457A) Source correlation tool set (HP B4620B)
HP 16555A (qty. 3)	68-channel, 500 MHz timing, 110 MHz state analysis module
HP 16517A (qty. 1)	16-channel, 4 GSa/s high-speed timing module
HP 16534A	500 MHz, 2 GSa/s oscilloscope

Get the Most Out of HP Digital Debug Solutions

HP offers training in how to use HP logic analyzers with on-chip emulation as well as a variety of flexible consultation services. You can learn from HP's experienced Digital Systems Consultants who can help you maximize the utilization of your emulation and analysis system. Digital Systems Consultants are peaked in debugging complex digital hardware, software problems and hardware/software integration.

HP training may be delivered through scheduled courses, on-site classes, or one-on-one consulting. HP training courses include extensive hands-on and are designed to pay off immediately in real-world situations. For the beginner HP offers the following introductory class:

16700A+24C Basic Digital Logic and Analysis

For users upgrading from an existing logic analysis system to the HP 16700 or HP 16600 series system, HP offers the following:

16700A+24M Advanced Logic Analysis Techniques for Hardware Debug

16700A+24X Advanced Logic Analysis Techniques for Software Debug

Call **1-800-593-6632** in the U.S., or **1-800-561-3276** in Canada for information about training schedules and location or to register.

For training offered in other geographies and languages, consult the HP test and measurement education web site:

<http://www.hp.com/go/tmeducation>

Bring In the Experts

HP offers a broad range of consulting services. HP's lab management services can help you make the best use of your new and existing debug

tools by helping with system installation, system maintenance, customized training and debug tool planning. In addition, HP consultants can provide expert, on-site help to solve tough digital debug problems by showing you how to apply HP tools and debug best practices. Contact your local HP sales representative for more information on HP consulting services available in your area.

For More Information

You can access the latest HP product information on the World Wide Web. Check out the following Web location for specific information on HP logic analysis systems and microprocessor emulation solutions:

<http://www.hp.com/go/las-data>

Related HP Literature

Refer to the documents below for more information on HP logic analysis systems and accessories.

Publication Title	Publication Type	HP Publication Number
<i>State and Timing Analyzers for the HP 16500C Logic Analysis System</i>	Product overview	5962-7245E
<i>Oscilloscope Modules for HP Logic Analysis Systems</i>	Product overview	5966-3150E
<i>System Configuration for the HP 16600A and 16700A Series Logic Analysis Systems</i>	Configuration guide	5966-3148E
<i>HP Logic Analysis Systems Upgrade</i>	Product overview	5966-3059E
<i>Emulation and Analysis Solutions for the Motorola MPC 8XX Microprocessors</i>	Product overview	5966-2866E
<i>Passively Probing a Motorola MPC 860/821 BGA Target System with HP E5346A High-Density Termination Adapters</i>	Product note	5966-4165E
<i>Emulation and Analysis Solutions for the Motorola PPC 6XX Microprocessors</i>	Product overview	5966-2868E
<i>Passively Probing a Motorola/IBM Power PC 603/603e BGA Target System with HP E5346A High-Density Termination Adapters</i>	Product note	5966-4167E
<i>Emulation and Analysis Solutions for the Motorola PPC 7XX Microprocessors</i>	Product overview	5966-2867E
<i>Passively Probing a Motorola/IBM Power PC 740/750 Target System with HP E5346A High-Density Termination Adapters</i>	Product note	5966-4166E
<i>Emulation and Analysis Solutions for Intel Pentium Processors and Pentium Processors with MMX Technology</i>	Product Overview	5966-3106E
<i>Emulation and Analysis Solutions for ARM7 Microprocessors</i>	Product Overview	5966-3442E

HP 16700A/16600A/ 16601A/16602A/16603A Common Technical Information

Mass Storage

- Hard disk drive capacity 4 GB standard
- Floppy disk drive capacity 1.44 MB formatted (Format DOS)

Internal System RAM

- 64 MB standard
- 160 MB total RAM (included in option 003)

Monitor Resolution Supported

- 1280 X 1024 standard
- 1600 X 1200 optional (requires option 003)

LAN, IEEE 802.3

- Physical connectors for 10Base-T (*ethertwist*) and 10Base2 (*thinlan*)
- LAN protocols supported: TCP/IP, NFS, FTP, SNMP

X-Windows Support

- X Windows system, version 11, release 6, as a client and server

Printing

- Printer parallel interface supported for Centronics-compatible printers
- Printers supported which support the HP Printer Control Language (PCL)
- Network printing is supported
- Graphic files can be created in black-and-white or color TIFF format, PostScript™, PCX, or XWD formats

Intermodule bus (IMB)

- Time correlation resolution 2 ns (HP 16700A only)

Port In/Out

- Connectors: BNC
- Port in
 - Levels TTL, ECL, or user defined
 - Input resistance 4 K Ω nominal
 - Input voltage -6 V at -1.5 mA to +6 V at 1.6 mA
- Port out
 - Levels: 3V TTL compatible into 50 Ω
 - Functions latched (latch operation module dependent)
 - Pulsed, width from 66 ns to 143 ns

Target control port

- Number of signals: -8
- Levels 3-V TTL compatible
- Connectors: 2 rows of 5 pins, 0.1-inch centers

Accessories supplied

- One DIN keyboard
- One three-button DIN mouse
- One ten-conductor, flying-lead cable for target control port
- Two 17-conductor flying-lead probe cables (HP 16600 series only)

Operating Environment

Temperature

Instrument	0 °C to 50 °C (32 °F to 122 °F)
Disk media	10 °C to 40 °C (50 °F to 104 °F)
Probes/cables	0 °C to 65 °C (32 °F to 149 °F)

Altitude To 3000 m (10,000 ft)

Humidity 8 to 80% relative humidity at 40 °C (104 °F)

Power

HP 16700A	115/230 V, 48 to 66 Hz, 610 W max
HP 16701A	115/230 V, 48 to 66 Hz, 545 W max
HP 16600A	115/230 V, 48 to 66 Hz, 190 W max
HP 16601A	115/230 V, 48 to 66 Hz, 190 W max
HP 16602A	115/230 V, 48 to 66 Hz, 190 W max
HP 16603A	115/230 V, 48 to 66 Hz, 190 W max

Weight*

	Max Net	Max Shipping
HP 16600A	10.0 kg (22.1 lb)	25.2 kg (55.6 lbs)
HP 16601A	10.0 kg (22.1 lb)	25.2 kg (55.6 lbs)
HP 16602A	10.0 kg (22.1 lb)	25.2 kg (55.6 lbs)
HP 16603A	10.0 kg (22.1 lb)	25.2 kg (55.6 lbs)
HP 16700A	12.7 kg (27.0 lb)	34.2 kg (75.4 lbs)
HP 16701A	10.4 kg (23.0 lb)	32.0 kg (70.6 lbs)
HP 1184A	48.0 kg (106.0 lb)	59.0 kg (130.0 lb)

* Weight of modules ordered with mainframes will add 0.9 kg (2.0 lb) per module.

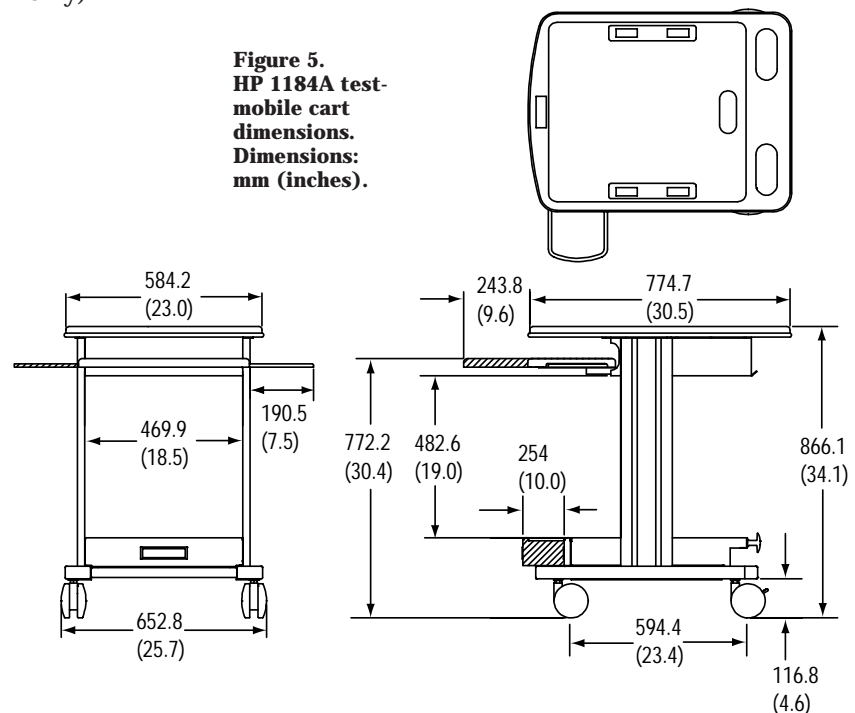

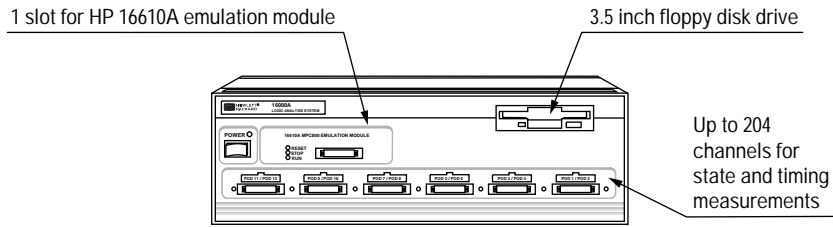

Figure 6. HP 16600A Series front panel

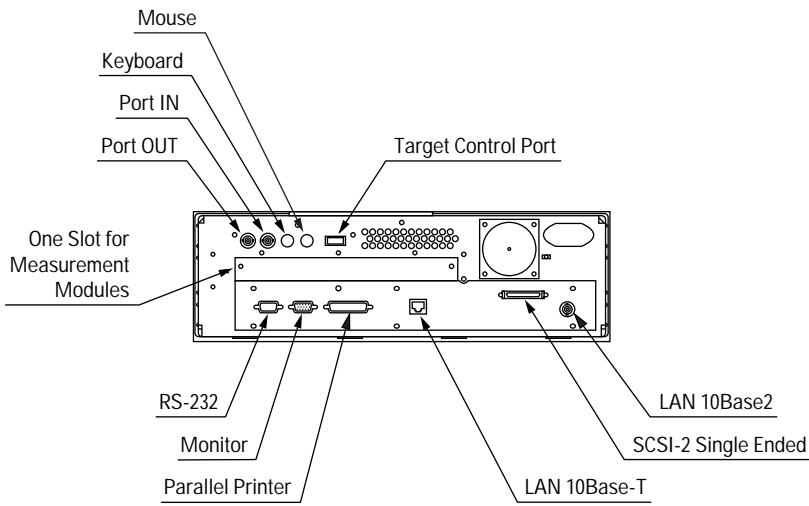

Figure 7. HP 16600A Series rear panel

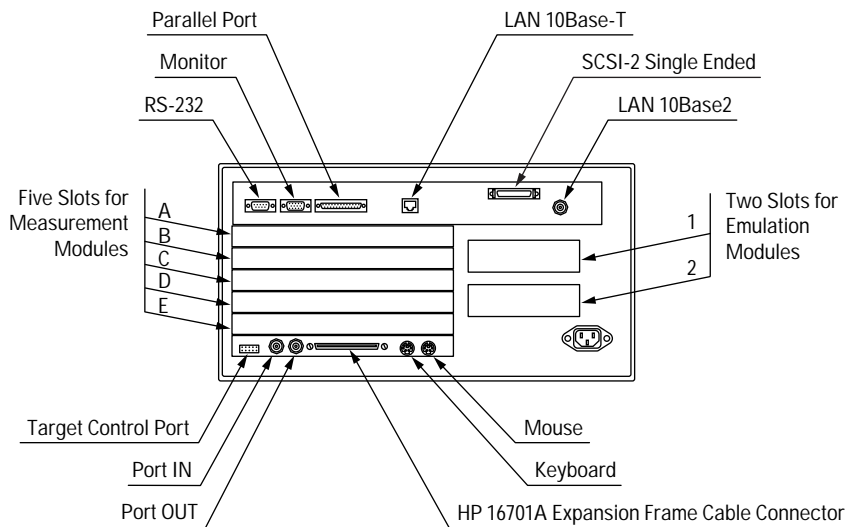

Figure 8. HP 16700A Series rear panel

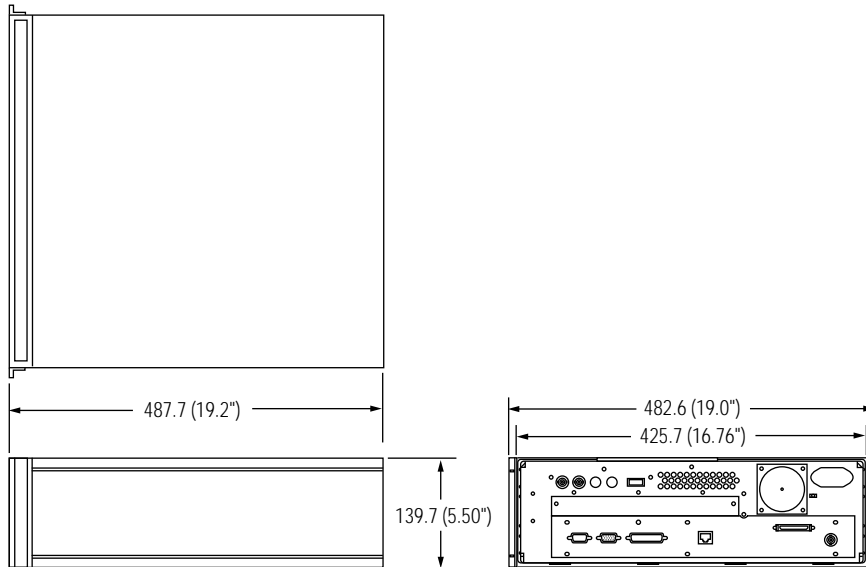

Figure 9. HP 16600A series exterior dimensions. Dimensions: mm (inches).

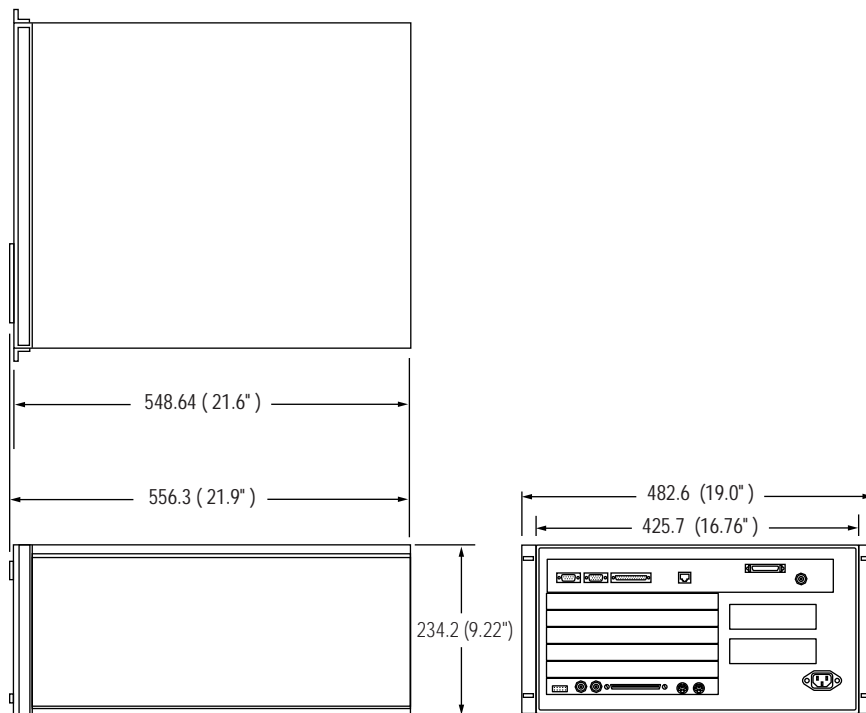

Figure 10. HP 16700A and 16701A exterior dimensions. Dimensions: mm (inches).

Warranty

HP hardware products are warranted against defects in materials and workmanship for a period of one year from date of shipment. If you send us a notice of such defects during the warranty period, we will either repair or replace hardware products that prove to be defective.

HP software and firmware products that are designated by HP for use with a hardware product are warranted for a period of one year from date of shipment to execute their programming instructions when properly installed. If you send us notice of defects in materials workmanship during the warranty period, we will repair or replace these products, so long as the defect does not result from buyer-supplied hardware or interfacing. The warranty period is controlled by the warranty statement included with the product and begins on the date of shipment.

Supplemental Characteristics for the HP 16600A/16601A/16602A/16603A

Probes

Input resistance	100 K Ω \pm 2%
Input capacitance	~8 pF
Minimum voltage swing	500 mV peak-to-peak
Threshold range	\pm 6.0 V, adjustable in 50 mV increments

State Analysis

Setup/hold time [1]	4.5/0 ns through 0/4.5 ns adjustable in 500 ps increments
Minimum state clock width	3.5 ns
State clock/qualifiers	6/6 (HP 16600A/16601A/16602A) 4/4 (HP 16603A)
Time tag resolution	8 ns
Maximum time count between states	39 hours
Number of machines available	2 state or 1 state/1 timing (HP 16600A, 16601A, 16602A) 1 state or 1 timing (HP 16603A)
Context Store block sizes	16/32/64 states

Timing Analysis

Sample period accuracy	0.01% of sample period
Channel-to-channel skew	2 ns typical
Time interval accuracy	\pm (sample period + channel-to-channel skew + 0.01% of time interval reading)

Triggering

Maximum sequencer speed	100 MHz
State sequence levels	12
Timing sequence levels	10
Maximum occurrence counter value	1,048,575
Pattern recognizers	10
Range recognizers	2
Range width	32 bits each
Timers	2
Timer value range	400 ns to 500 seconds

[1] Minimum setup/hold time specified for single-edge, single clock acquisition. Single-clock multi-edge setup/hold window is 5 ns. Multi-clock, multi-edge setup/hold window is 5.5 ns. All setup/hold windows are adjustable in 500 ps increments.

Ordering Information

For both the HP 16600A and the HP 16700A Series mainframes, HP recommends that you order a monitor (option 001) and at least one CD-ROM drive (option 004). The CD-ROM drive is necessary to load future software upgrades.

Each HP 16600A Series logic analysis system includes two sets of 17-channel probe leads (34 channels total) as standard equipment. If you require additional pairs of probe leads, order option 010.

Accessories

The HP testmobile cart gives you a convenient means of organizing your HP logic analysis system mainframes and accessories.



Figure 11. HP 1184A testmobile cart

HP 16600A, 16601A, 16602A, 16603A Logic Analysis System Options

- 001 Add 17-inch 1280 × 1024 monitor and cable
- 003 Performance system upgrade 160 MB total system RAM, 2 MB total video RAM
- 004 Add CD-ROM drive
- 010 Add two sets of 17-channel probe leads (34 channels)
- 0B3 Add service guide
- 1CM Add rack-mount kit
- W17 Convert 1-year return-to-HP warranty to 1-year on-site warranty
- W30 Extend standard warranty to 3-year return-to-HP warranty
- W50 Extend standard warranty to 5-year return-to-HP warranty

HP 16700A Logic Analysis System Options

- 001 Add 17-inch 1280 × 1024 monitor and cable
- 003 Performance system upgrade 160 MB total system RAM, 2 MB video RAM
- 004 Add CD-ROM drive
- 0B3 Add service guide
- 1CM Add rack-mount kit
- W17 Convert 1-year return-to-HP warranty to 1-year on-site warranty
- W30 Extend standard warranty to 3-year return-to-HP warranty
- W50 Extend standard warranty to 5-year return-to-HP warranty

HP 16701A Logic Analysis Expansion Frame Options

- 1CM Add rack-mount kit
- W17 Convert 1-year return-to-HP warranty to 1-year on-site warranty
- W30 Extend standard warranty to 3-year return-to-HP warranty
- W50 Extend standard warranty to 5-year return-to-HP warranty

For more information about the HP 16600A and 16700A Series logic analysis systems, visit our web site at: <http://www.hp.com/go/las-data>

For more information about Hewlett-Packard Test & Measurement products, applications, services, and for a current sales office listing, visit our web site at: <http://www.hp.com/go/tmdir> You can also contact one of the following centers and ask for a test and measurement sales representative.

United States:

Hewlett-Packard Company
Test and Measurement Call Center
P.O. Box 4026
Englewood, CO 80155-4026
1 800 452 4844

Canada:

Hewlett-Packard Canada Ltd.
5150 Spectrum Way
Mississauga, Ontario
L4W 5G1
(905) 206 4725

Europe:

Hewlett-Packard
European Marketing Centre
P.O. Box 999
1180 AZ Amstelveen
The Netherlands
(31 20) 547 9900

Japan:

Hewlett-Packard Japan Ltd.
Measurement Assistance Center
9-1, Takakura-Cho, Hachioji-Shi,
Tokyo 192, Japan
Tel: (81) 426 56 7832
Fax: (81) 426 56 7840

Latin America:

Hewlett-Packard
Latin American Region Headquarters
5200 Blue Lagoon Drive
9th Floor
Miami, Florida 33126
U.S.A.
Tel: (305) 267-4245/4220
Fax: (305) 267-4288

Australia/New Zealand:

Hewlett-Packard Australia Ltd.
31-41 Joseph Street
Blackburn, Victoria 3130
Australia
Tel: 1 800 629 485 (Australia)
0800 738 378 (New Zealand)
Fax: (61 3) 9210 5489

Asia Pacific:

Hewlett-Packard Asia Pacific Ltd.
17-21/F Shell Tower, Times Square,
1 Matheson Street, Causeway Bay,
Hong Kong
Tel: (852) 2599 7777
Fax: (852) 2506 9285

Technical information in this document is subject to change without notice.