



HP 250

**Preparing
for Your HP 250**

Preparing for Your HP 250

Manual Part No. 45260-90040



Hewlett-Packard Company

8010 Foothills Blvd., Roseville, CA 95678

FEDERAL COMMUNICATION COMMISSION RADIO
FREQUENCY INTERFERENCE STATEMENT

The United States Federal Communications Commission (in Subpart J, of Part 15, Docket 20780) has specified that the following notice be brought to the attention of the users of this product:

“Warning: This equipment generates, uses, and can radiate radio frequency energy and if not installed and used in accordance with the instructions manual, may cause interference to radio communications. It has been tested for compliance with the limits for Class A computing devices pursuant to Subpart J of Part 15 of FCC Rules, which are designed to provide reasonable protection against such interference. Operation of this equipment in a residential area is likely to cause interference in which case the user at his own expense will be required to take whatever measures may be required to correct the interference.”

“This product has been tested and licensed by the Fernmeldetechnisches Zentralamt (FTZ) for use in West Germany. Included with the system is a registration postcard to be completed and mailed for all German installations.”

NOTICE

The information contained in this document is subject to change without notice.

HEWLETT-PACKARD MAKES NO WARRANTY OF ANY KIND WITH REGARD TO THIS MATERIAL, INCLUDING, BUT NOT LIMITED TO, THE IMPLIED WARRANTIES OF MERCHANTABILITY AND FITNESS FOR A PARTICULAR PURPOSE. Hewlett-Packard shall not be liable for errors contained herein or for incidental or consequential damages in connection with the furnishing, performance or use of this material.

Hewlett-Packard assumes no responsibility for the use or reliability of its software on equipment that is not furnished by Hewlett-Packard.

This document contains proprietary information which is protected by copyright. All rights are reserved. No part of this document may be photocopied, reproduced or translated to another program language without the prior written consent of Hewlett-Packard Company.

Preface

Purpose of This Manual

The purpose of this manual is to assist in the planning and preparation for installation of the HP250 Computer System, Models 30, 40, and 50. For information on the Model 26, see “HP250 Model 26 Site Preparation and Installation Guide.”

The information and specifications will help you decide where to locate the system, how to prepare the environment, what to do for receiving and unpacking, and what you must have ready when the Hewlett-Packard Customer Engineer comes to install the system.

Hewlett-Packard has made an intensive design effort to make the HP 250 System adaptable to the typical office environment. It is not economically feasible to provide for operation in all possible environments. This Guide is designed to simplify the site preparation process by presenting the various specifications so that they will be understood by a first-time computer user. Each specification is explained with details on the reason for the requirement and the person responsible for its implementation.

You are responsible for scheduling, planning, and preparing a suitable site for installation of an HP 250 Computer System. Hewlett-Packard site planning representatives are available for consultation on planning physical requirements of the installation.

How This Manual Is Organized

The manual is a reference for site preparation of the HP 250 Computer System. Various planning aids are provided to smooth your planning and installation. The major parts of the manual are:

An “Introduction” outlining your responsibilities for preparing for your HP 250 System, Hewlett-Packard’s responsibilities to you for assistance, a timeframe for setting up your system, and the people you may look to for assistance.

“Preparing for Installation” including floor plans, power specifications, atmospheric considerations, connecting cables, communication configurations, and system shipping weights.

“Providing Other Necessities” such as media storage, record protection, computer supplies, and ready phone access to assistance which are an integral part of preparing for and operating a computer.

“When Your System Arrives” discusses the final preparation for system arrival, coordinated deliveries, how to check for damage and schedule installation, unpacking the cartons, and the arrival date of your HP 250.

An “Appendix” containing a pre-installation worksheet, site completion checklist, and HP 250 Space Planning Kit to aid you in preparing your HP 250.

Contents

1. Introduction

Customer Responsibilities	1-1
Space and Environment	1-1
Approvals	1-1
Local Codes	1-1
Data Communications Equipment	1-1
Selection of Principal Operator	1-1
HP Services	1-1
Site Planning Visit	1-1
Site Verification	1-2
System Installation	1-2
What Should I Do Next?	1-2
Six Weeks Before Installation	1-2
Two Weeks Before Installation	1-2
At System Delivery	1-2
At System Installation	1-3
Where Do I Go for Help?	1-3
Local Hewlett-Packard People Who Can Help You	1-3
For System or Software Purchased from a Third Party	1-3
The Experts	1-3

2. Preparing for Installation

Floor Plan	2-1
HP 250 Power Requirements	2-1
Why Power Requirements Are Important	2-1
Sources of Electrical Interference	2-8
Convenience Wall Outlets	2-8
Lightning	2-8
Radiated Interference	2-8
Atmospheric Considerations	2-8
Flammable Materials	2-8
Airborne Contaminants	2-8
Temperature and Humidity	2-9

Interconnecting Cables and Power Cords	2-12
General Information	2-12
HP-IB Cables	2-12
Communications	2-12
Asynchronous Serial Interface (ASI)	2-12
Attaching Terminals to the HP 250	2-18
Asynchronous Modems for ASI	2-19
Intelligent Network Processor (INP)	2-21
Synchronous Modems and Auto Call Units for INP/250	2-21
System Size and Weight	2-24

3. Providing Other Necessities

Media Storage	3-1
Protection of Valuable Records	3-1
Computer Supplies	3-1
Telephone	3-1

4. When Your System Arrives

Preparation for System Arrival	4-1
Coordinated Deliveries	4-1
Check for Shipping Damage	4-1
Schedule the Installation	4-1
Unpack the Cartons	4-1
System Installation Day	4-2

Appendix

HP 250 Pre-Installation Worksheet	A-1
HP 250 Space Planning Kit	A-3
Site Completion Checklist	A-7

Tables

1-1. When You Need an Expert	1-4
2-1. Worksheet for Power Requirements Calculations	2-3
2-2. Calculation of Heat Output by Machine Type	2-10
2-3. Terminal Switch Settings	2-18
2-4. HP Supported Asynchronous Modems	2-19
2-5. HP Supported Synchronous Modems and Automatic Calling Units	2-21
2-6. System Component Shipping Weights and Dimensions	2-24

Figures

2-1. Electrical Circuit Diagram (U.S.A. and Canada)	2-4
2-2. Electrical Circuit Diagram (Other Countries)	2-5
2-3. Power Cords	2-6
2-4. Allowable Transient and Surge Voltage Amplitudes	2-7
2-5. Temperature and Humidity Requirements	2-9
2-6. Room Temperature Rise	2-11
2-7. HP-IB Cabling Configurations	2-13
2-8. ASI Cable Connections	2-14
2-9. ASI Current Loop Connections (262X Terminals)	2-15
2-10. ASI Current Loop Connections (264X Terminals)	2-16
2-11. Fabricating Your Own Three-Wire Cable	2-17
2-12. INP Cable Connections	2-21

CHAPTER 1

Introduction

Customer Responsibilities

HP Services

What Should I Do Next?

Where Do I Go for Help?

Customer Responsibilities

Space and Environment

The HP 250 system has been designed for the office environment and no extensive preparation is required. However, the customer is responsible for providing suitable space and environment for the complete system.

Specifications for all requirements are given in Chapter 2.

Approvals

The HP 250 Office Computer Series has the following regulatory approvals:

Safety:

- UL 114, Office Appliances & Business Equipment
- UL 478, Data Processing Equipment
- CSA C22.2 No. 154, Data Processing Equipment

RFI:

- HP 45260A, FTZ License No. C-032/81
- HP 250/35, FTZ License No. C-013/78
- HP 2649D-050, FTZ License No. C-106/76

Data Communications:

- Germany, United Kingdom, Australia, France, Belgium, Finland, Switzerland, Sweden
- Note: U.S.A. does not require regulatory approval.

Local Codes

In some localities, special codes and regulations may exist for the installation of computer sites. It is your responsibility to ensure that the requirements of all local laws, regulations, and codes for mechanical, building, and electrical distribution systems have been complied with for the site prior to the system delivery.

Data Communications Equipment

When data communications equipment, such as modems and connecting cables, is required, you are responsible for ordering and installing the communications equipment.

Selection of Principal Operator

You should appoint someone to be the Principal Operator. This person is responsible for system operation, maintenance, and scheduling. Initially, the Principal Operator is responsible for monitoring site preparation schedules, ordering computer supplies, and scheduling training for users of the system. In the process, the Principal Operator should become familiar with the HP 250 System and be ready to start its operation when the system is installed.

HP Services

Site Planning Visit

Upon Hewlett-Packard's receipt of the purchase order for your computer system, your HP Customer Engineer (CE) will contact you to arrange an on-site meeting with your Principal Operator and your electrician. At that meeting, site planning and preparation requirements will be discussed.

As one part of the site preparation service, the Customer Engineer will evaluate the power source and electrical wiring at the site. Normally, an isolated-ground dedicated circuit is required. In some cases, additional equipment may be necessary—such as one or more HP 35030A Power Line Conditioners, depending on the number of peripherals.

Site Verification

The HP Customer Engineer will call you before installation and check on the progress of site preparation. On the day of installation, the CE will check that the site has been prepared according to this Guide and verify that the site is suitable. There should be no problem with acceptance if this Guide is followed. Sites failing to meet verification requirements, causing installation delays long enough to require a second visit, are subject to additional service charges. HP provides services during warranty and under a maintenance agreement if the specified requirements are met.

System Installation

When your system arrives, your HP Customer Engineer will install it on a mutually-agreed-upon date. Refer to Chapter 4 for the tasks performed.

What Should I Do Next?

The following guidelines describe general site planning. The suggested schedule is a summary of the HP 250 Pre-Installation Worksheet found in Appendix A-1. It should be used to monitor the progress of site preparation so that the site is complete when the system is delivered. Since the time from placing an order to actual delivery is flexible, the suggested schedule should be compressed or expanded accordingly.

There are two items that require several weeks lead time. They are: (1) arranging for an electrician to do electrical wiring and (2) placing orders for any needed data communications equipment. HP suggests that the suppliers of those services be contacted as soon as possible after order placement.

Six Weeks Before Installation

1. Assign a person (Principal Operator) to be responsible for the successful installation and operation of your HP 250 system.
2. Select the location for your HP 250 Computer System. Your HP Customer Engineer will schedule a site planning visit with you and answer any questions about site preparation.
3. Plan the physical arrangement of the system and furniture.
4. Order consumable supplies, including flexible discs or tape cartridges for system backups.

Two Weeks Before Installation

1. Schedule the date for installation of the HP 250 System with your local HP 250 Customer Engineer.

At System Delivery

1. Inspect each component shipment as it is delivered.
2. Call the HP CE office when all equipment has arrived.
3. Have all of the equipment at the site location where it is to be installed before the HP CE arrives.

At System Installation

1. Have your Principal Operator present to assist and advise the HP Customer Engineer throughout the installation process.

The remainder of this manual provides you with the information needed to complete the planning and preparation process. If you require any assistance, contact your local HP Sales Representative.

Where Do I Go for Help?

Local Hewlett-Packard People Who Can Help You

To assist you in understanding the Hewlett-Packard organization, descriptions are given of the HP people who will contact you. Each member of the HP team is a well-trained expert, dedicated to seeing that you get the maximum benefit from your HP 250.

Sales Representative—The HP Sales Representative is your primary contact. Your Sales Representative coordinates HP resources to ensure successful delivery and installation of your system. Later, when you need additional system capabilities or staff training, your Sales Representative is the person to call.

Customer Engineer (CE)—The Customer Engineer is an expert in computer and peripheral equipment service—with the tools, parts, and know-how to install and maintain your HP 250. You will meet your local CE during the site planning visit and installation of your computer. In addition, an HP Maintenance Agreement for hardware can be purchased which provides hardware maintenance, repair, and problem diagnosis by CEs.

Systems Engineer (SE)—The Systems Engineer is a technical specialist in all HP 250 subsystems and the programming language. Your local SE organization provides training courses and technical consulting on your system's language, utility programs, data base management, and system performance. The HP 250's Customer Support Service plan (CSS) provides for software consulting and problem diagnosis by SEs.

For System or Software Purchased from a Third Party

Original Equipment Manufacturer (OEM) or System House—If you have purchased an HP 250 computer system and/or applications software from a third party, that party will provide consultation services on system operation and applications software (programs). In this situation, a Maintenance Agreement for hardware and CSS for standard HP software is available from Hewlett-Packard.

The Experts

Unless you are an electrician and a computer engineer, you need the assistance of an electrician, a Hewlett-Packard (HP) Customer Engineer, and an HP Systems Engineer. These experts provide you with the technical knowledge necessary for your HP 250 site preparation and maintenance. Table 1-1 summarizes the technical tasks which may require expert assistance and lists the expert capable of providing that assistance.

Table 1-1. When You Need an Expert

A summary of experts on technical assistance. Each of these tasks is discussed in further detail in Chapter 2.

If you need . . .	Call your . . .
Line voltages measured	Electrician
Power line frequencies measured and recommendations for improvements made	HP Customer Engineer (HP CE)
Safety and isolated ground connections verified	Electrician
Advice on correct circuit breakers and wire sizes	Electrician
Power line noise levels measured	HP CE
Neutral-ground voltages measured during installation	HP CE
Verification that your mainframe outlets (those used for floor cleaners, etc.) are on separate circuits from your HP 250	Electrician
Recommendations about lightning protection	HP CE
Measurements and recommendations on radiated interference	HP CE
Answers to your questions concerning modems and modem options	HP Systems Engineer (SE)
Know which modems your HP 250 System supports	HP SE

At this time, you should know who your HP Customer and Systems Engineers are; if you do not, contact your Hewlett-Packard Regional

Sales Office, Sales Representative, or independent supplier for assistance.

CHAPTER 2

Preparing for Installation

Floor Plan
HP 250 Power Requirements
Sources of Electrical Interference
Atmospheric Considerations
Interconnecting Cables and Power Cords
Communications
System Size and Weight

Floor Plan

You need to select a location to satisfy immediate and future requirements. You may want to select your computer site so that you can add more equipment as your needs expand.

HP recommends that you prepare a floor plan of your own HP 250 site showing the location and arrangement of your equipment. Provide enough space for people to work efficiently and for servicing equipment. The "Space Planning Kit," located in Appendix A-3, can help you plan the physical layout of your HP 250 site. The kit contains views of all of the HP 250 equipment and a grid layout.

HP 250 Power Requirements

One of the most important considerations is the system electrical power requirements. HP 250 power requirements for all systems are:

- **Line voltage** Single Phase
100/120/220/240V,
+5%–10%.

Nominal	Range
100	90 to 105
120	108 to 126
220	198 to 231
240	216 to 252
- **Line frequency** 50 Hz or 60 Hz, $\pm 3.5\%$ ($\pm 0.2\%$ for 264X terminals or 2649D Remote 250) ($\pm 1\%$ when writing IBM-format flexible discs).
- **Separate circuit breakers** Available current cannot exceed 75% of circuit breaker rating.
- **Safety and reference (isolated) ground** Required protection of operating personnel and for system reference.

- **Power line transients** Power transients and interference less than specified value for HP 250 System
- **Neutral-ground voltage** Less than 1.0 volts RMS at each outlet with system components installed and powered on.

Why Power Requirements Are Important

The following section explains the purpose and function of the power requirements listed above. Included here are the people capable of assisting you in meeting these requirements.

a. Line Voltage— The AC line voltage at the wall outlet is a function of the local power utility and your building power distribution. A local power utility is required to provide a certain voltage range at the customer meter. The voltage drop inside a building is related to the wiring from the meter to the wall outlet.

Supplied voltages outside of the operating range of the system can cause intermittent system errors or shutdown. Low voltage is usually the problem and is probably caused by inadequate wiring.

Your electrician can make measurements and determine if the proper wire sizes are used.

b. Frequency— Frequency is normally a function of the local power utility. In rare instances, power may be supplied by a motor-generator set within your building. Shifts in frequency can cause intermittent system errors or CRT display jitter.

Your HP Customer Engineer can measure the power line frequency and make a recommendation if improvements are needed.

c. Separate Circuit Breakers (Dedicated Circuits)— There are two reasons for requiring separate circuit breakers for your computer. The first is to ensure that no other electrical devices are connected to the same circuit to prevent unnecessary tripping of a circuit breaker. For example, in your own kitchen, if you brew coffee in an automatic coffee maker (12 amperes) at the same time as you are making toast in a toaster (10 amperes), you would trip the circuit breaker if both appliances are on the same circuit.

The second reason for dedicated circuits is to ensure that there is sufficient power to run the

system. Lack of separate circuit protection and inadequate wiring cause low voltage (insufficient power) and can cause intermittent system operation, e.g., system crashes, disc errors.

Circuit breakers are rated in amperes. In the U.S.A., typical circuit breakers are 15 or 20 amperes. The ampere load in each individual circuit breaker should allow a margin for startup and surge currents drawn by the system. Refer to Table 2-1 to determine the number of circuit breakers.

Use this table to calculate your HP 250 System's power requirements. Depending on the configuration (component combination) you

use, the power requirements differ between systems. Have your electrician double check your calculations.

Table 2-1. Worksheet for Power Requirement Calculations

HP 250 Machine Type	Model	(A) Amperage Drawn (depends upon local voltage)				(B) Multiply by Number of Machines	(C) Total Machine Amperage (A) • (B) = (C)
		Local Voltage:					
		100V	120V	220V	240V		
Mainframe	Model 30, 40, 50 System Unit (incl. 2622D)	3.7	3.1	1.6	1.5		
	Model 35 System Unit	3.4	2.8	1.5	1.4		
Disc Drive	7908P	5.2	4.3	2.3	2.1		
	7906H	7.7	6.4	3.5	3.2		
	7911P/7912P	8.4	7.0	4.0	3.5		
Terminal	2621A	0.5	0.4	0.2	0.2		
	2621P	1.4	1.2	0.6	0.6		
	2622D	1.2	1.0	0.5	0.5		
	264X	1.6	1.3	0.7	0.7		
	2649D	1.3	1.1	0.7	0.6		
	3075A / 3076A / 3077A	0.9	0.75	0.41	0.375		
	3081A with 92922A	0.6	0.5	0.27	0.25		
	39800A	0.24	0.2	0.11	0.1		
Printer	2601A	1.6	1.3	0.8	0.7		
	2602A	1.0	0.9	0.5	0.5		
	2608A	13.0	10.8	5.9	5.4		
	2631B	1.8	1.5	0.8	0.7		
	2563A	6.0	5.0	2.7	2.5		
	2687A	8.4	7.0	3.82	3.5		
	2932A	3.0	2.5	1.36	1.25		
	2933A	3.0	2.5	1.36	1.25		
	2934A	3.0	2.5	1.36	1.25		
	82905B	1.0	0.8	0.4	0.4		
Plotter	7220C /T	1.3	1.1	0.6	0.6		
	7221C /T	1.3	1.1	0.6	0.6		
	7225B	1.0	1.0	0.5	0.5		
	7470A	0.3	0.2	0.1	0.1		

HP 250 Computer System total amperage _____
 Plus 35% for start-up and surge current _____
Total amperage with protection _____

Note: Where multiple circuits are needed to provide the required total amperage protection, consult local electrical codes to determine the appropriate circuit breaker sizes and load distribution (maximum breaker in the United States is 20 Amps; in Canada, 15 Amps).

The electrical wiring diagram in Figure 2-1 shows wiring for a U.S.A. 120V-20A circuit breaker with isolated ground receptacles. Specifications for wire sizes in Figure 2-1 are predicated on the maximum size breaker being 20 amperes (U.S.A.). Canada uses 15 amperes. Equivalent wiring diagram for other countries is shown in Figure 2-2 for 220 or 240 volt input and isolated ground. This figure shows typical circuit breaker or fuse and wire size for countries other than the U.S.A. and Canada. All sizes are based on the input voltage being 220 or 240 volts.

Your electrician will advise you on correct circuit breakers and wire sizes.

d. Safety and Reference (Isolated) Ground-
 — The green-wire ground serves the dual function of safety and reference ground. As a

safety ground, this wire meets requirements for any electrical equipment as protection for the user. As a reference ground, the green wire acts as the electronic base point for the computer. The green-wire ground is connected to the metal frame of each system component to protect an operator against equipment malfunction, and make the equipment resistant to a catastrophic event such as a lightning strike. To preserve this protection, do not plug the system into wall outlets that have no ground connections. Be sure that the green ground wire is connected from the outlet to the distribution sub-panel where the circuit breaker is installed. An HP 250 operating as a total system requires interface communication between the mainframe and all peripherals. As a result, all items within the system (except workstations or terminals connected via current loop or through

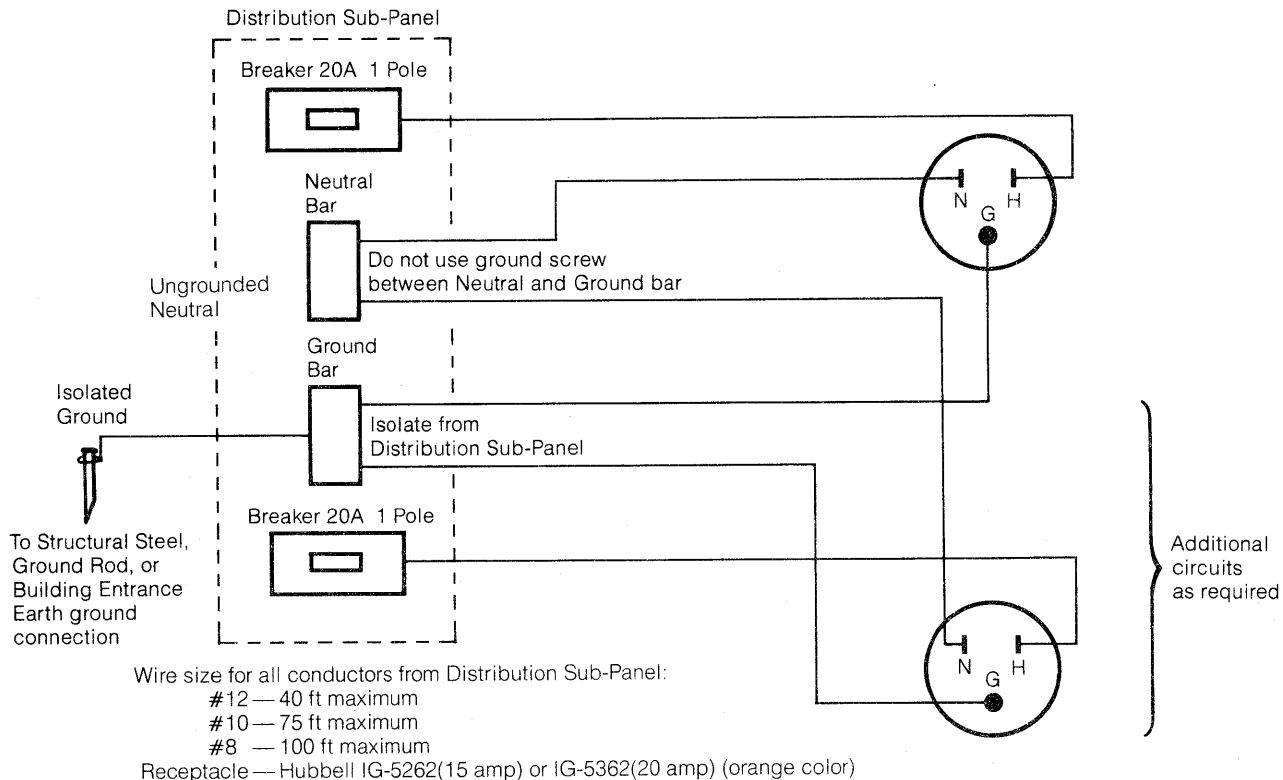

Figure 2-1. Electrical Circuit Diagram (U.S.A. and Canada)

modems) must have a common (single point) system reference ground. Otherwise, erroneous signals can be generated between devices and cause intermittent system failures. Furthermore, the system isolated ground must be "quiet," i.e., other electrical devices such as copying machines, arc welders and air-conditioning motors cannot be connected to the computer system ground. Therefore, the computer system ground is electrically separate back to the main building entrance earth ground.

To meet the requirements for safety and reference ground, the ground wires for all of the outlets used by the computer and peripheral equipment must be connected to the same ground bar (separated from the neutral) at the distribution sub-panel. A single ground wire

should run from the distribution sub-panel to structural steel, ground rod (must be bonded to building entrance earth ground), building entrance earth ground connection, or an already-installed computer system ground (see Figure 2-1 or 2-2). Conduit must not be used for computer system ground return, and all ground conductors must be insulated.

HP 250 computer and peripherals are equipped with three-conductor power cords which, when connected to appropriate power receptacles, ground the individual components of the system. Figure 2-3 shows the various U.S.A. and international power cords offered with the system.

Have your electrician verify that the safety/reference ground is connected properly.

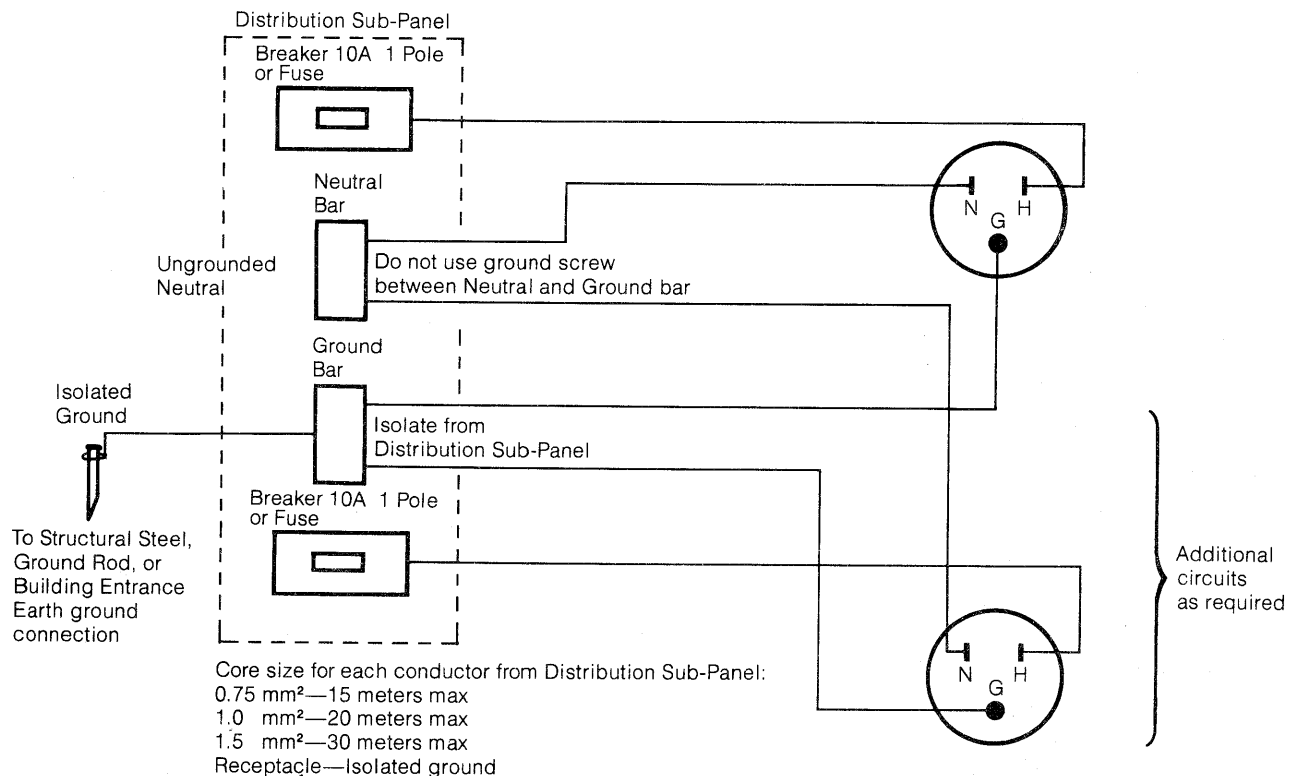

Figure 2-2. Electrical Circuit Diagram (Other Countries)

e. Power Line Transients— Heavy electrical loads from nearby machinery or equipment, i.e., elevators or electric welders, can cause intermittent system errors even if that equipment is on a different circuit breaker. For those conditions, you must provide a separate, completely independent circuit with isolated ground and circuit breaker coming directly from the main building power source. In extreme cases of severe electrical noise, it may be

necessary to install an isolation or power line conditioning transformer.

Your HP Customer Engineer can measure the power line noise level (see Figure 2-4), and make the appropriate recommendation if power line improvement is needed.

f. Neutral-Ground Voltage— If the neutral-ground voltage is greater than 1V RMS, this is an indication of (1) inadequate wire size,

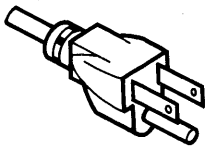

U.S.A., Canada, Japan, Mexico, Philippines, Taiwan
Standard
HP Part Number: 8120-2371
Length: 2.29m (7.5 ft)
Rating: 125V, 13a, single phase
NEMA5-15P

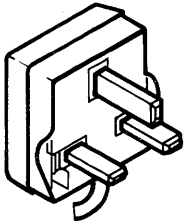

Great Britain, Cyprus, Nigeria, Rhodesia, Singapore
Option 900
HP Part Number: 31000-60057
Length: 2.29m (7.5 ft)
Rating: 250V, 10a, single phase
BS 1363A

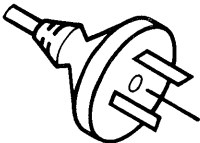

Australia, New Zealand
Option 901
HP Part Number: 8120-1369
Length: 2m (6.5 ft)
Rating: 250V, 6a, single phase
AS C112

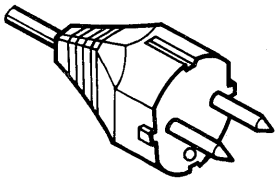

Belgium, Italy, France, Spain, Greece, Austria, Finland, Germany, Netherlands, Norway, Sweden, Saudi Arabia, United Arab Republic
Option 902
HP Part Number: 8120-2857
Length: 2m (6.5 ft)
Rating: 250V, 6a, single phase
CEE7-VII

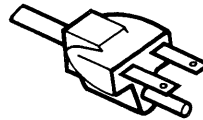

U.S.A., Canada, Japan, Mexico, Philippines, Taiwan
Option 904
HP Part Number: 8120-0698
Length: 2.29m (7.5 ft)
Rating: 250V, 6a, single phase
NEMA6-15P

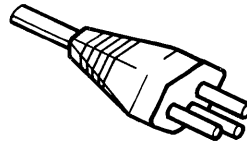

Switzerland
Option 906
HP Part Number: 8120-2104
Length: 2m (6.5 ft)
Rating: 250V, 6a, single phase
SEV 1011

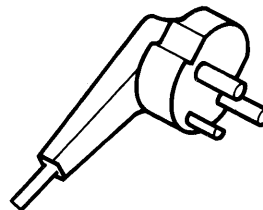

Denmark
Option 912
HP Part Number: 8120-2956
Length: 2m (6.5 ft)
Rating: 250V, 6a, single phase
DHCR 107

Figure 2-3. Power Cords

(2) absence of ground wire, (3) poor building distribution ground, or (4) imbalance of phases on a 3-phase power distribution system. The result can be intermittent system errors or system shutdown.

Your HP Customer Engineer will measure the neutral-ground voltage during installation. If the voltage exceeds the specification, your electrician can determine which of the four conditions is the problem, and rectify the situation appropriately.

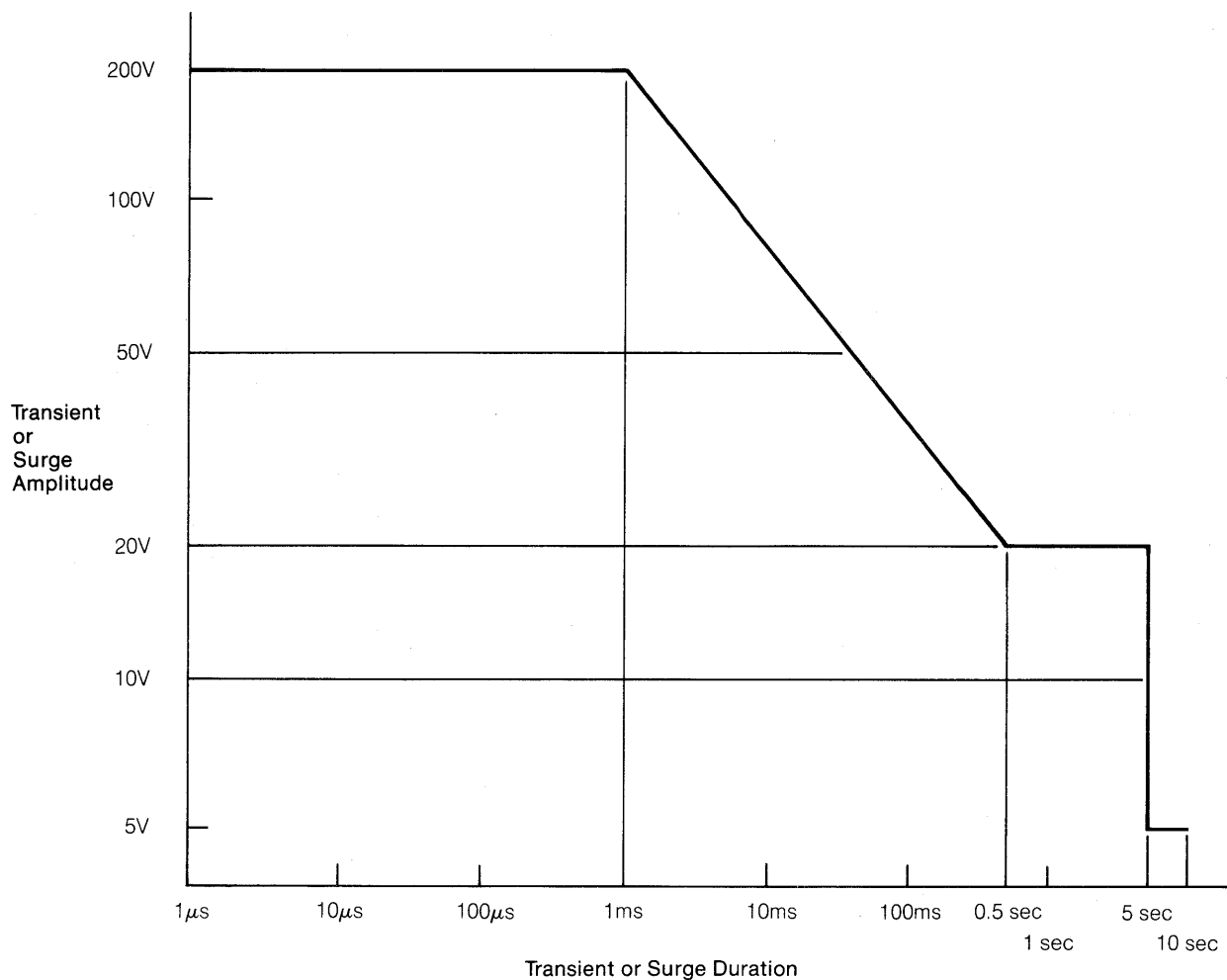

Figure 2-4. Allowable Transient and Surge Voltage Amplitudes

Sources of Electrical Interference

Convenience Wall Outlets

Power outlets for building maintenance equipment (vacuum cleaners, floor buffers, etc.) must be wired on a circuit breaker separate from the computer. Connect the green ground wire for these outlets to the normal building distribution ground (not computer system ground). If a separate circuit breaker and separate grounding is not provided, operation of janitorial equipment can induce electrical noise and cause abnormal operation of the computer system.

Your electrician can verify that maintenance outlets are on separate circuits.

Lightning

In some geographic areas it may be advisable to install lightning protection for personnel and the computer. In the U.S.A., the installation of lightning arrestors on power and communication lines is described in the National Electrical Code, Article 280. The principles of lightning protection and personnel safety are given in the lightning protection code contained in the NFPA Handbook.

Your HP Customer Engineer may recommend lightning protection equipment for some geographic areas.

Radiated Interference

Radiated interference causes a variety of problems in computer systems. Most commonly, disc read/write errors can occur because of the interference. The most common sources of radiation are airports, which have communications and radar installations, business two-way radio transmitters, or broadcast radio/TV transmitters. Hand-held transceivers (i.e., "walkie-talkies") produce the same effect as radio stations when used in or

near computer equipment and should therefore be prohibited from the areas in which computer equipment is installed. Additionally, a microwave link is sometimes aimed from adjacent buildings—this presents trouble for the computer system if it is installed in the transmission path.

HP 250 Computer Systems are designed to withstand levels of radiation up to 0.5 volt/meter over a frequency range of 14 kHz to 1 GHz.

If you think there could be a problem with radiated interference at your site, call your HP CE about making interference measurements. You may need the assistance of an outside consultant for recommendations on shielding the system from external interference.

Atmospheric Considerations

Flammable Materials

Fundamental safeguards for the computer system include a location within a building that will be away from outside sources of potential damage. The HP 250 System should not be installed or operated in an environment where there is a hazard of fire or explosion due to the existence of highly flammable gases, flammable volatile liquids, or combustible dust in the area.

Airborne Contaminants

Temperature and humidity control does not eliminate disc problems if the environment you work in is unclean. Airborne contaminants and particles of a certain size and hardness may scratch either the coating on the disc or the drive head and cause premature wear on the disc, resulting in data errors.

Some of the most common contaminants are dust, smoke, ashes, eraser crumbs, and bread crumbs. Solvent vapors, such as those from liquid spirit duplicating equipment and wet process copiers, can soften disc coatings over a period of time. To prevent excessive wear, avoid bringing these contaminants into contact with your computer.

Temperature and Humidity

Operating temperature and humidity requirements are shown in Figure 2-5.

Avoid extremes in relative humidity. High humidity levels can cause improper feeding and stacking of printer paper or improper operation of disc drives. Low humidity levels aggravate problems of static electricity and cause excessive flexible disc wear.

Carpeting can be a source of static electricity, especially in dry and cold climates. Static discharge can often be reduced significantly by a humidifier. Other ways to minimize static discharge are using mats (with ground strap) in front of the system or treating the carpet with anti-static spray. Spray is not recommended, however, because it finds its way into the system intake filter and coats the circuitry. If spray is used, it should be applied while the system is turned off.

The HP 250 Computer System is air cooled, with fans bringing cool air into the system, circulating it, and exhausting heated air from the rear of the system into the room. Remember to place each system component at least 1 meter (3 ft.) from a wall to allow heated air to exhaust properly. Table 2-2 will help you calculate the total system heat output of your particular configuration.

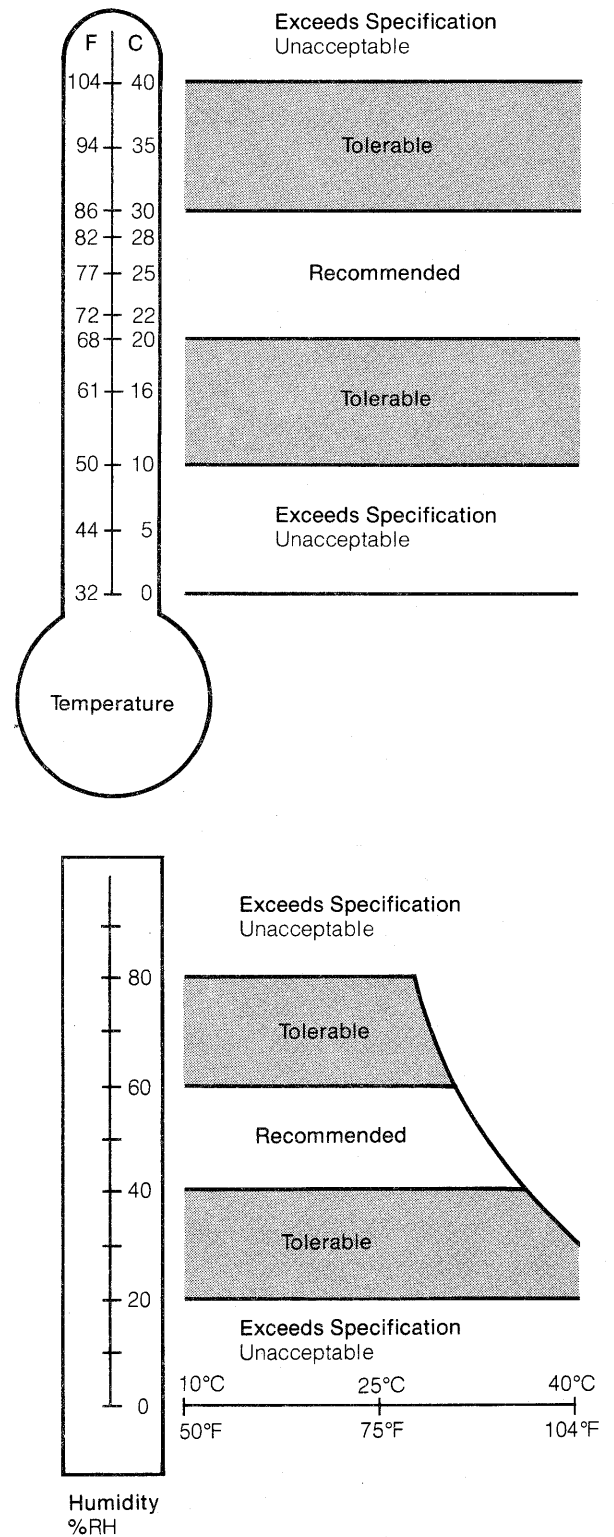

Figure 2-5. Temperature and Humidity Requirements

Table 2-2. Calculation of Heat Output by Machine Type

HP 250 Machine Type	Watts	BTU/hr	Multiply By Number of Machines	Equals Total Heat Output per Machine Type
HP 250 Model 30, 40, 50 (incl. 2622D)	275	940		
7906H Disc Drive	550	1880		
7908P Disc Drive	370	1260		
7911/7912P Disc Drive	700	2593		
2631B Printer	150	510		
2601 Printer	120	410		
2602A Printer	90	315		
2608A Printer	850	2900		
2563A Printer	230	784		
2687A Printer	840	2864		
2932A Printer	225	768		
2933A Printer	225	768		
2934A Printer	225	768		
82905B Printer	100	341		
2621A Terminal	40	140		
2621P Terminal	90	300		
264X Terminal	100	341		
2649D Workstation	100	341		
2622D Workstation	65	220		
3075A/3076A/3077A Data Capture Terminals	90	307		
3081A Data Capture Terminal with 92922A Adapter	45	154		
39800A Bar Code Reader	25	85		
7220C/T Plotter	100	341		
7221C/T Plotter	100	341		
7225B Plotter	70	240		
7470A Plotter	25	85		

Your HP 250 System Heat Dissipation

Total

As a guideline for the temperature environment, Figure 2-6 indicates the temperature rise in the area you select, depending upon the room size and the system heat output. Determine the new office temperature by adding the existing office temperature and the temperature rise taken from the graph. (Readings for existing temperatures should be taken near the floor in the approximate area where the equipment will be located.)

The system will operate most reliably if the room temperature is maintained between 20–30 degrees Celsius (68–86 degrees Fahrenheit). Mechanical parts fail primarily by wearing out, but, due to the physics of semiconductors, higher operating temperatures considerably increase failure rate of electronic circuitry. The statistics of semiconductor failure show that if you were to operate the system continually in a room temperature of 32 degrees Celsius (90 degrees Fahrenheit), you would have 25% more component failures than if operated at 25 degrees Celsius (76 degrees Fahrenheit).

If the building air conditioning is turned down or off on weekends, and you intend to use your system, we recommend you check the temperature and humidity of the computer site to determine whether the operating specifications are exceeded. If the specifications are exceeded, you should provide auxiliary air conditioning to prevent system shutdown or damage to equipment.

You can purchase an inexpensive thermometer and humidity gauge at a hardware or department store to determine the temperature and humidity environment of your site.

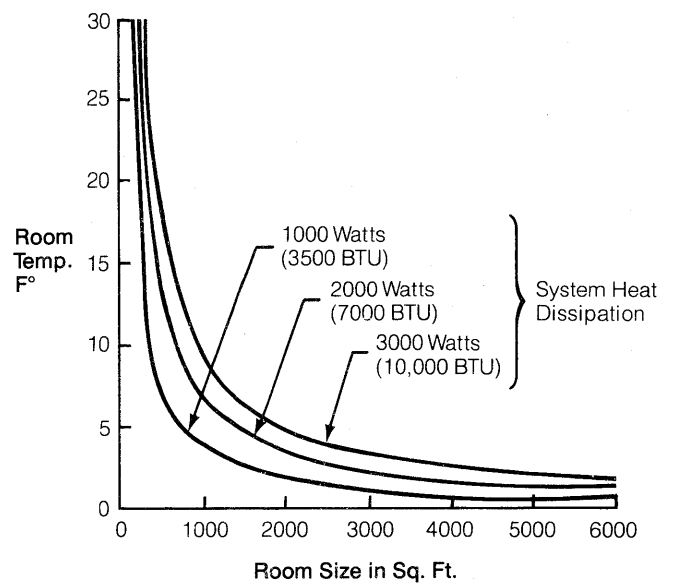
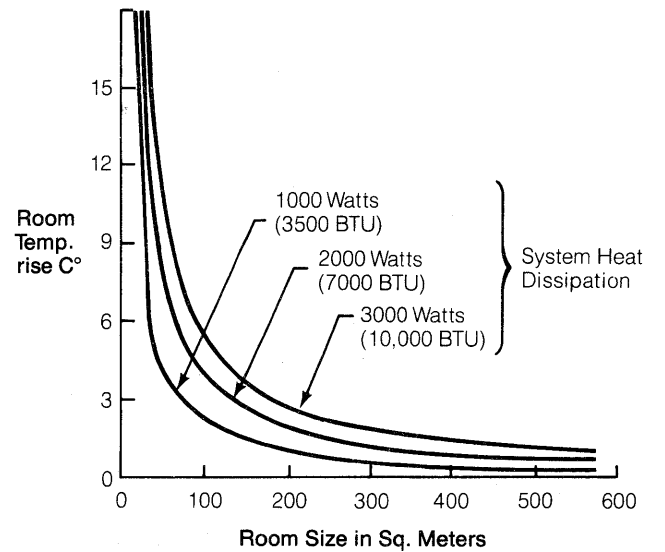

Figure 2-6. Room Temperature Rise

Interconnecting Cables and Power Cords

General Information

Data cables connect the HP 250 to all of its peripheral equipment. When planning the physical layout of your HP 250 site, consider the functional and aesthetic effects of the routing of these cables, and locations of wall outlets for power cords.

In general, cables should not be routed across entrances, aisles, or traffic paths or under carpeting. In these areas, cables can be a safety hazard, or damage to the wiring can occur. Remember, due to cable routing, the distance separating the external equipment from the computer will be less than the lengths of the data cables.

The U.S.A. and Great Britain power cords are 2.29 meters (7.5 ft.) in length. All other power cord lengths are 2 meters (6.5 ft.). **EXTENSION CORDS FOR POWER MUST NOT BE USED UNDER ANY CIRCUMSTANCES.** They cannot provide enough power to the system and can be a safety hazard.

All of the cables and power cords enter and exit from the rear of the equipment. Therefore, it is favorable to locate the equipment along walls where power outlets are easily accessible and where interconnecting cables will be out of the way.

HP-IB Cables

The Hewlett-Packard Interface Bus (HP-IB) provides a means by which system components communicate with each other. It is analogous to a party line telephone system in which several people share a single line. In the HP 250 System, the HP-IB cables connect the disc memory devices and printers with the System Processing Unit (SPU).

In Figure 2-7, you can determine how much cable is shipped with your particular system configuration. (You do not have to locate your system components in the same physical locations as shown in the examples.) The figure also shows the recommended configurations.

Communications

Either a direct hardwired connection or telephone equipment (asynchronous or synchronous modem) is used for communication between terminal equipment and the computer. The following information will help you plan and install your communications equipment. Also remember that you must have all communications equipment and extension cables installed before the system installation date if the complete system installation is to be accomplished on the day requested.

Asynchronous Serial Interface (ASI)

The Asynchronous Serial Interface (ASI), HP Product 45120A/B, is capable of communicating with supported terminals, printers, and plotters via an RS-232-C data link, using either a direct hardwired connection or modems. The EIA RS-232-C standard defines the mechanical/electrical characteristics for devices which can connect to the ASI interface. The standard does not specify the protocol (handshaking sequences, control line use, or control character sequences). Hewlett-Packard supports operation of the RS-232-C data link only with the specific devices, modems, and modem options shown in Figure 2-8. Any changes in supported modems and options are reported in the Configuration Guide which is available from your HP Sales Representative.

Device	External length of cable supplied (meters)		
HP 250 System Unit	0	HP 2932A Printer	0
HP 7906H Disc	2	HP 2933A Printer	0
HP 7908P Disc	2	HP 2934A Printer	0
HP 7911P/7912P Disc	1	HP 2563A Printer	2
HP 2631B Printer	2		
HP 2608A Printer	2		

Recommended Configurations: (Disregard any devices you do not have, but keep the devices in the order shown.)

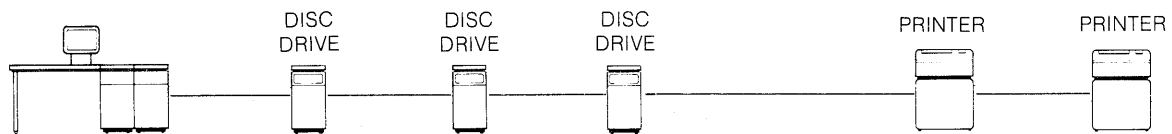

- Note ● Other configurations are possible. However, this configuration is the most reliable, especially in larger configurations. (If you have a 2608A printer, it should be the outside printer.)
- The specific cable lengths between any two devices can be determined by you as long as the total cable length on the system does not exceed that supplied with the system peripherals. (For the HP 2932A, 2933A, and 2934A, the HP-IB cable must be obtained separately. Assume 2 meters of cable for each when computing maximum cable length for your system.) If you need more cable length, contact your HP Customer Engineer to ensure that the additional cable length conforms to HP-IB specifications.
 - Do not connect two HP-IB cables together. For example, if you need a two-meter cable between devices, use one two-meter cable. Do not connect two one-meter cables together.

Figure 2-7. HP-IB Cabling Configuration

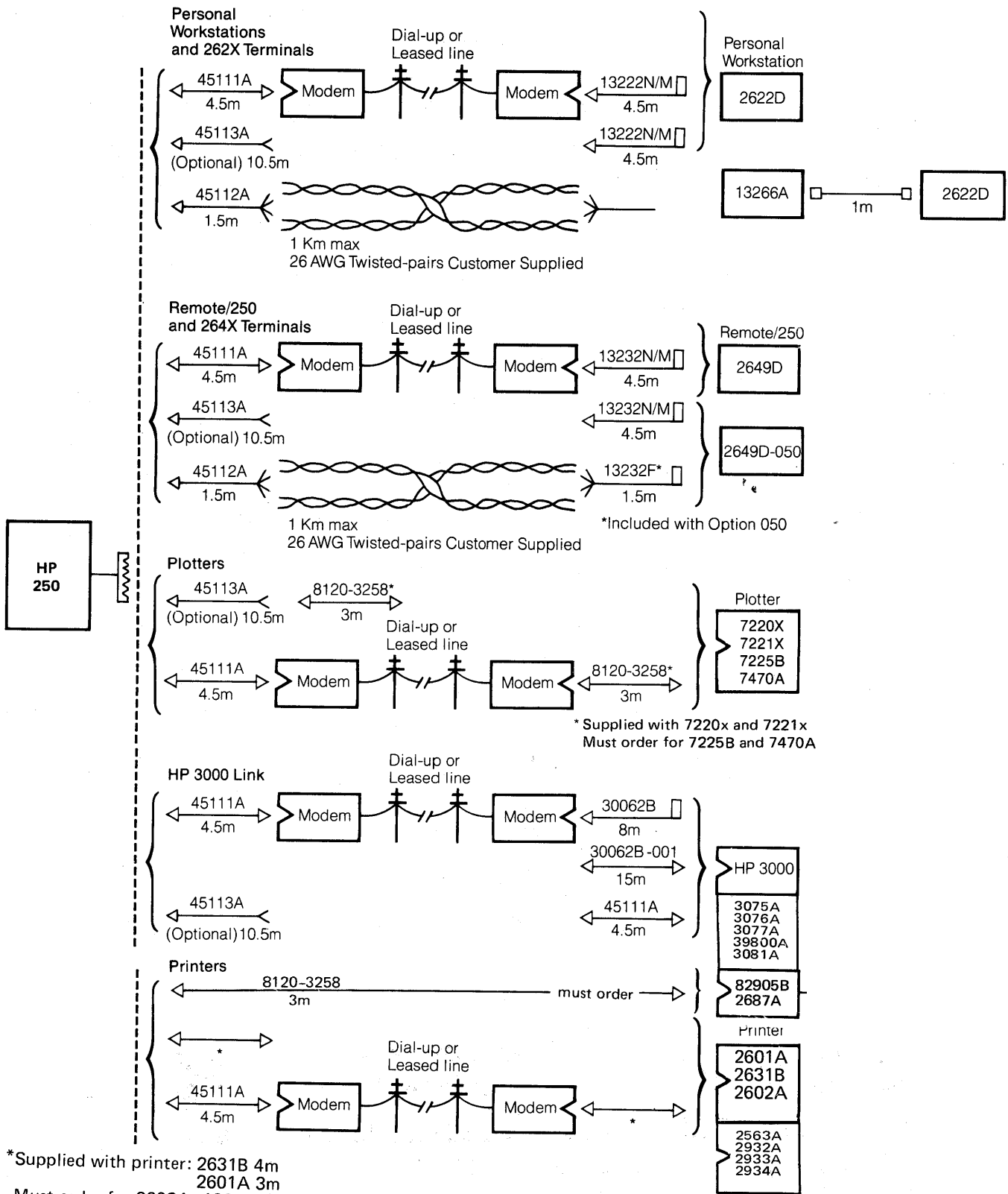

*Supplied with printer: 2631B 4m
 2601A 3m
 Must order for 2602A: 13242n/m
 Must order for 2563A
 Must order for 2932A
 Must order for 2933A
 Must order for 2934A

Figure 2-8. ASI Cable Connections

262X Terminal Connected to ASI with Current Loop Connection

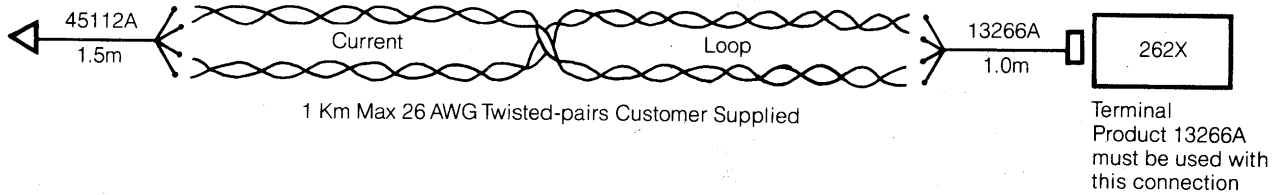

Cable Wiring for Current Loop Connection

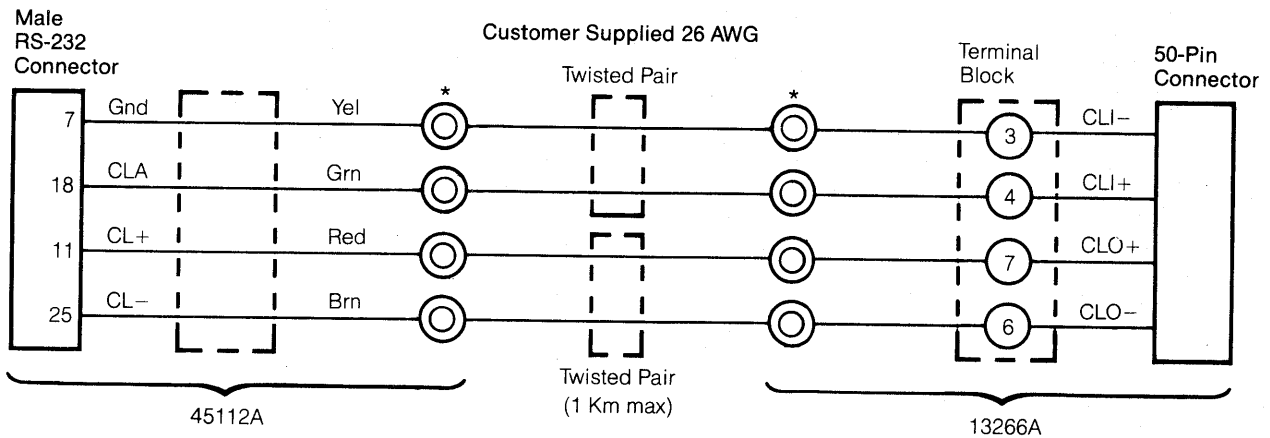

- CLA — Current Loop Transmit
- Gnd — Signal Ground
- CL+ — Current Loop Receive (in)
- CL- — Current Loop Receive (out)

- CLI- — Current Loop Receive (out)
- CLI+ — Current Loop Receive (in)
- CLO+ — Current Loop Transmit (out)
- CLO- — Current Loop Transmit (in)

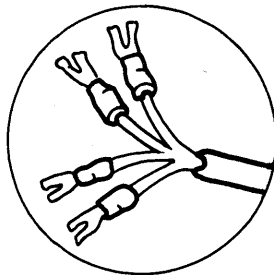

*Detail of cable end:

10-Position Rocker Switch Setting. Inside 13266A POD

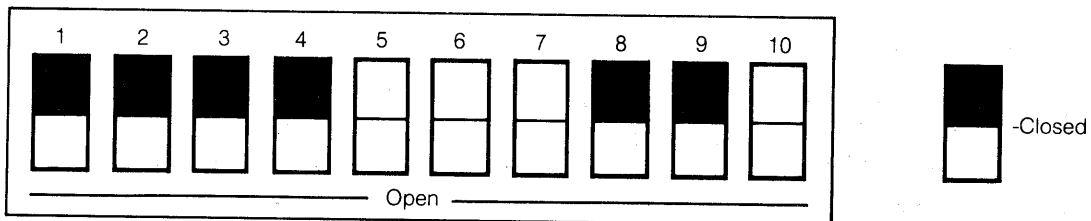

Note: Self-test switch should be in normal position.

(262X Terminals)

If you locate an HP 262X or 264X terminal further than 15 meters (50 ft.) from the computer without using a modem, a current loop connection can be used for distances up to 1 kilometers (0.6 mile). Refer to Figure 2-9 or 2-10 for details on making the cable and all required connections.

If you should need to fabricate your own data communications three-wire cable, refer to Figure 2-11 for details on making the cable and all required connections. This particular cable configuration is not supported by HP.

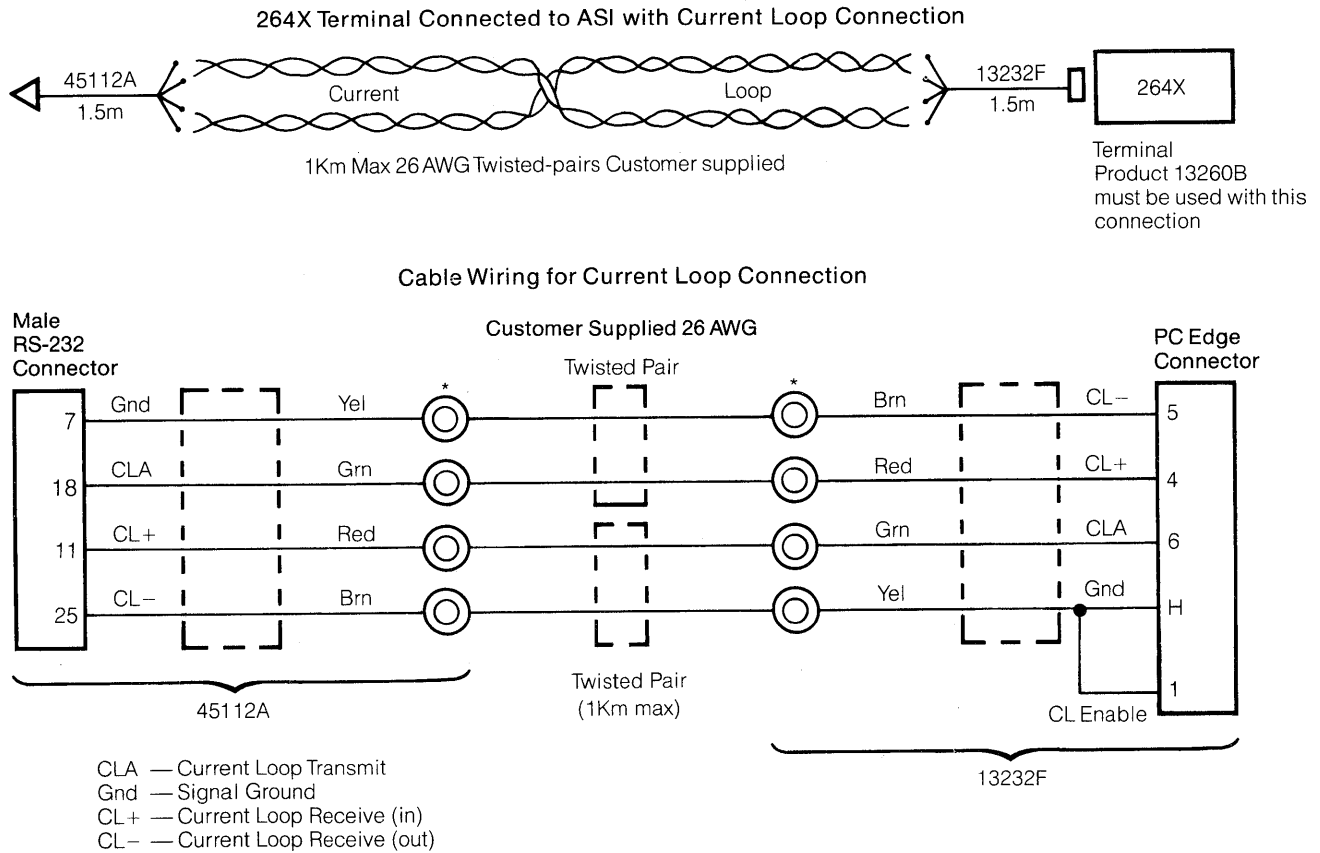

Terminal Product 13260B must be used with this connection

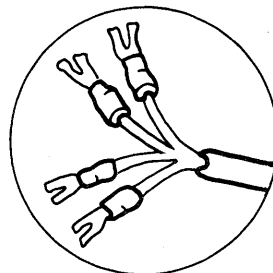

*Detail of cable end:

Figure 2-10. ASI Current Loop Connections (264X Terminals)

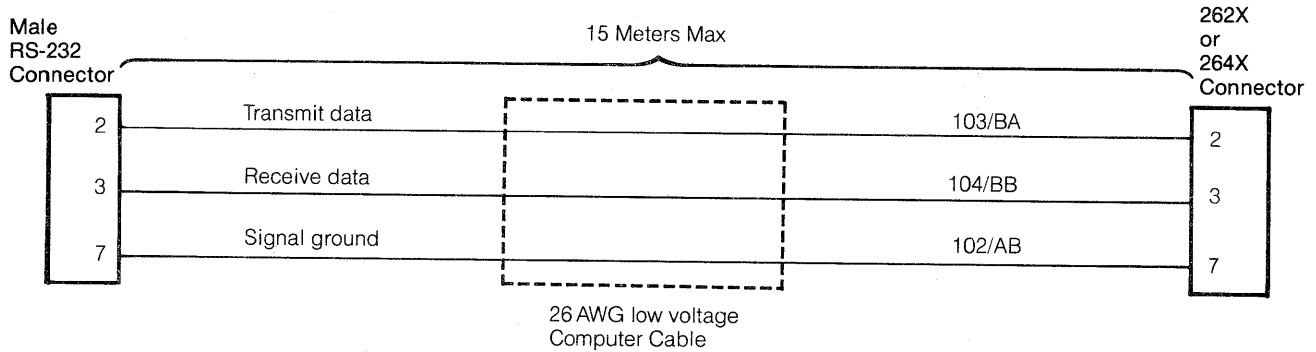

Item	HP Part No.	Description	Alternate Source
RS-232 Connector Kit	5061-2405	Includes male and female RS-232 Connectors (1 each)	
264X PCA Hood Connector Kit	5061-1340	Includes one 25-pin Connector	
262X Connector Kit	5061-2412	Includes one 50-pin Connector	Amphenol 57-30500
Connector Cable	8120-1950	12 conductor, shielded	U.L. style 2560
	8120-2398	16 conductor, shielded	U.L. style 2560

Note to Installer: On HP 250 Computer, port switch configuration is

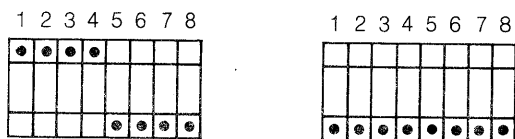

or jumper configurations 1-10 are A's on RS-232 Connector Board Assembly.

Figure 2-11. Fabricating Your Own Three- Wire Cable

Attaching Terminals to the HP 250

To attach a supported terminal or workstation to the HP 250, switches (straps) located on interface boards inside the terminal (except for the 262X series where the settings are selected from the keyboard) must be set to specific

positions. Refer to the individual terminal reference manuals for specific instructions on how to set these switches. Table 2-3 lists the correct switch settings for all currently supported terminal types.

Table 2-3. Terminal Switch Settings

Terminal	Board		Setting
2640B, 2645A, 2647A, 2648A, 2649D	Keyboard interface board 02640-60123		Strap A-H closed strap J-N closed strap P-X closed strap Y open strap Z closed all others closed.
	I/O interface board (use one of these three)	Standard asynchronous communication interface 02640-60086	No strapping
		General purpose asynchronous communication interface 02640-60089*	Strap A9 closed strap A10 closed strap A11 closed strap CBE closed strap NOSB closed all others open.
	Extended asynchronous communication interface 02640-60143*	Strap A9 closed strap A10 closed strap A11 closed strap CBE closed strap NOSB closed all others open.	
2621A/P	Programmable configuration parameters (Set from keyboard)		Baud rate, =<9600 parity: none (0) duplex: full straps: bcgHxZ handshake: Etx HZ: 50 or 60 Start Col: 1 Return: Cr.

*Also used for current loop.

Asynchronous Modems for ASI

The HP 250 ASI supports only the modems with the defined straps and options listed in Table 2-4. Because the actual connection and control of an RS-232-C data link can be and is broadly

interpreted, HP can support only those modems which we have tested. If you have questions concerning modems or modem options, please contact your local HP Systems Engineer (SE).

Table 2-4. HP Supported Asynchronous Modems

Data Set	Baud Rate	Type of Line
Bell 103J	300 Baud	Switched, Full Duplex
Bell 212A	300/1200 Baud	Switched, Full Duplex

Required feature configurations for the Bell 103J Data Set follow:

Bell 103J Data Set

Feature	Required Configuration
Receive space disconnect	Yes
Send space disconnect	Yes
Loss of carrier disconnect	Yes
CC indication	Early
CB and CF indications	Common
CC indication for analog loopback	On
Fail safe of CN circuit	Off
Automatic answer	Yes
Common grounds	Yes

Required feature configurations for the Bell 212A Data Set follow:

Bell 212A Data Set

Option	Feature	Required Configuration
A2	Disconnect options a.2. Send space (OUT) b.1. Receive space IN c.1. Loss of carrier (IN)	Yes Yes Yes
B3	With automatic answer	Yes
C6	EIA interface and ground a.1. DSR (CC) indication for analog loop (ON) b.1. CTS (CB) and DCD (CF) indication (COMMON) c.1. Signal ground to frame connection (IN) d.2. Answer mode indication (CE) (OFF) e. Interface speed indication (OUT) f. Speed control (HS button) g. Interface controlled Remote Digital Loop (OUT) h. CN and TM Test Mode Assignments – CN Pin 18 + TM Pin 25	Yes Yes Yes Yes Yes Yes Yes Yes
D8	Modes of operation a.1. 1200 baud asynchronous start/stop b.2. Character length—10 bit c.1. Transmitter timing—internal d.2. Speed mode—dual (1200 or 300) e.1. Receiver responds to digital loop (IN) f.2. Interface speed indications (OUT)	Yes Yes Yes Yes Yes Yes
E10	Make busy/analog loop (CN) circuit disabled (OUT)	Yes

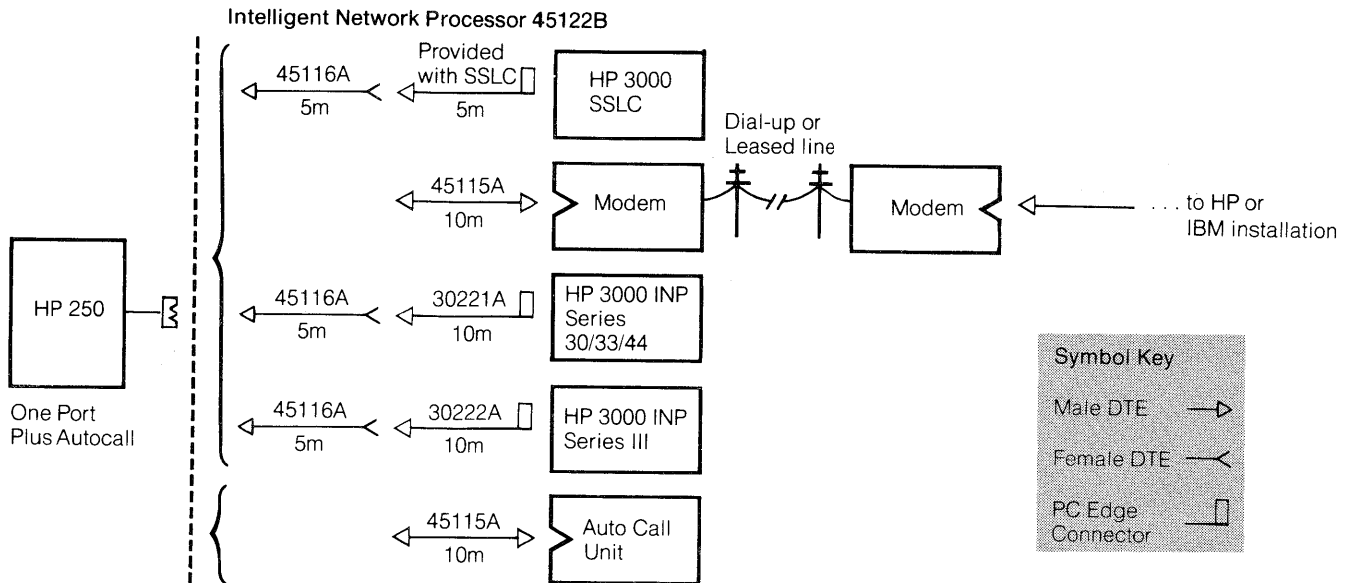

Figure 2-12. INP Cable Connections

Intelligent Network Processor

The Intelligent Network Processor (INP) communicates with other computers via a synchronous data link using either a direct hardwired connection or modems. The EIA RS-232-C and RS-366 standards define the mechanical/electrical characteristics for devices which can connect to the INP interface. The standards do not specify the protocol (handshaking sequences) control line use, or control character sequences. Hewlett-Packard supports operation of the RS-232-C and RS-366 data links with the devices, modems, and modem options shown in Figure 2-12.

Synchronous Modems and Auto Call Units for INP/250

The INP/250 supports only the the HP and Bell modems with the defined straps and options listed below. Because the actual connection and control of an RS-232-C or RS-366 data link can be broadly interpreted, HP can only support those modems which we have tested. If you have any questions concerning modems or modem options, contact your local HP SE. Use the information in Table 2-5 to order and install your modems and cables.

Table 2-5. HP Supported Synchronous Modems and Automatic Calling Units

Modem/ACU	Bit Rate	Type of Line	Line Conditioning
HP 37230A (Short Haul)	2400/4800 9600/19200 bps	Twisted Pair	None
Bell 201C	2400 bps	Public (Switched)	C2 or C4
Bell 208A	4800 bps	Private (Leased)	None
Bell 208B	4800 bps	Public (Switched)	None
Bell 209A	9600 bps	Private (Leased)	D1
Bell 801C-L2	Autocall	Public (Switched)	None

Required feature configurations for the modems and automatic calling units (ACU) are the following:

Bell 201C Data Set (Switched)

Option	Feature	Required Configuration
A1	Transmitter internally timed	Yes
B3	Without 801 Automatic Calling Unit	Optional
B4	With 801 Automatic Calling Unit	Optional
C5	EIA interface	Yes
D8	With automatic answer	Yes
E9	Automatic answer permanently wired	Optional
E10	Automatic answer key-controlled	Optional
—	Grounding	AA to AB

Bell 208A Data Set (Leased)

Option	Feature	Required Configuration
A1	Transmitter internally timed	Yes
B3	Continuous carrier	Yes
C6	Continuous Request To Send	Yes
D7	One second holdover used	Yes
E10	Without new sync	Yes
F11	CC ON when analog loop is present	Yes
—	Grounding	AA to AB

Bell 208B Data Set (Switched)

Option	Feature	Required Configuration
A1	Transmitter internally timed	Yes
B3	Without 801 Automatic Calling Unit	Optional
B4	With 801 Automatic Calling Unit	Optional
C6	CC ON when analog loop is present	Yes
D8	With automatic answer	Yes
E9	Desk mounting	Either
E10	Rack or cabinet mounting	Either
—	Grounding	AA to AB

Bell 209A Data Set (Leased)

Option	Feature	Required Configuration
A1	Transmitter internally timed	Yes
C6	Slaved Transmitter timing by receiver	Out
D8	Elastic store out	Yes
E9	Continuous carrier	Yes
F12	Continuous Request To Send	Yes
—	Data Set Ready circuit	CC off
—	Grounding	AA to AB
—	With or without alternate service	Either

Bell 801C-L2 Auto Call Unit (Switched)

Option	Feature	Required Configuration
A2	Signal ground not connected to frame ground	Yes
B4	Call terminated through data set after DSS on	Yes
C5	ACR timer stopped DSS on	Yes
D8	ACR timing interval specified by customer	Yes
	1. 7 seconds	25–28 seconds
	2. 14–15 seconds	
	3. 25–28 seconds	

System Size and Weight

Table 2-6 shows the weights of all available system components. Use the crated weights and dimensions to determine where you will uncrate

and transport the components in the building. The weight column is used to determine floor loading on the site that you have selected.

Table 2-6 System Component Shipping Weights and Dimensions

Component	Weight	Crated Weight	Crated Dimensions		
			Height	Width	Depth
HP 250 Model 30/40/50 System Unit	59 kg (130 lb)	86 kg (190 lb)	889 mm (35 in.)	1016 mm (40 in.)	610 mm (24 in.)
2631B Serial Printer	23 kg (50 lb)	30 kg (65 lb)	787 mm (31 in.)	635 mm (25 in.)	1016 mm (40 in.)
2608A Line Printer	101 kg (222 lb)	144 kg (317 lb)	889 mm (35 in.)	991 mm (39 in.)	1016 mm (40 in.)
2601A Printer	27 kg (60 lb)	33 kg (72 lb)	737 mm (29 in.)	737 mm (29 in.)	457 mm (18 in.)
2602A Printer	17 kg (37 lb)	23 kg (50 lb)	686 mm (27 in.)	660 mm (26 in.)	356 mm (14 in.)
2563A Printer	34 kg (75 lb)	38 kg (84 lb)	274 mm (10.75 in.)	600 mm (23.6 in.)	450 mm (17.71 in.)
2687A Printer	68 kg (150 lb)	72 kg (159 lb)	305 mm (12 in.)	510 mm (20 in.)	499 mm (19.6 in.)
2932A/ 2933A/ 2934A Printers	20.4 kg (45 lb)	23.2 kg (51 lb)	185 mm (7.28 in.)	600 mm (23.9 in.)	365 mm (14.3 in.)
82905B Printer	5.5 kg (12 lb)	8.6 kg (19 lb)	534 mm (21 in.)	483 mm (19 in.)	534 mm (21 in.)
2621A Terminal	16 kg (36 lb)	19 kg (42 lb)	533 mm (21 in.)	635 mm (25 in.)	660 mm (26 in.)
264X Terminals	23 kg (50 lb)	25 kg (56 lb)	533 mm (21 in.)	610 mm (24 in.)	660 mm (26 in.)

continued

Table 2-6 (continued) System Component Shipping Weights and Dimensions

Component	Weight	Crated Weight	Crated Dimensions		
			Height	Width	Depth
7906H Disc Drive	74 kg (164 lb)	121 kg (267 lb)	1016 mm (40 in.)	838 mm (33 in.)	1041 mm (41 in.)
7908P Disc Drive	73 kg (160 lb)	105 kg (230 lb)	660 mm (26 in.)	965 mm (38 in.)	940 mm (37 in.)
7911P/7912P Disc Drive	85 kg (188 lb)	118 kg (260 lb)	914 mm (36 in.)	914 mm (36 in.)	660 mm (26 in.)
2622D Workstation	23 kg (50 lb)	30 kg (65 lb)	533 mm (21 in.)	610 mm (24 in.)	610 mm (24 in.)
2649D Workstation	23 kg (50 lb)	25 kg (56 lb)	533 mm (21 in.)	610 mm (24 in.)	660 mm (26 in.)
7220C/T Plotter	29 kg (63 lb)	30 kg (65 lb)	787 mm (31 in.)	660 mm (26 in.)	432 mm (17 in.)
7221C/T Plotter	24 kg (53 lb)	25 kg (56 lb)	711 mm (28 in.)	660 mm (26 in.)	406 mm (16 in.)
7225B Plotter	12 kg (26 lb)	14 kg (30 lb)	559 mm (22 in.)	533 mm (21 in.)	330 mm (13 in.)
7470A Plotter	6.1 kg (13.5 lb)	12.6 kg (28 lb)	1295 mm (51 in.)	1219 mm (48 in.)	838 mm (33 in.)
3075A Terminal	6.6 kg (14.4 lb)	8.7 kg (19.1 lb)	260 mm (10.2 in.)	275 mm (10.8 in.)	420 mm (16.5 in.)
3076A/3077A Terminals	10.6 kg (23.5 lb)	12.7 kg (27.9 lb)	550 mm (21.7 in.)	440 mm (17.3 in.)	190 mm (7.5 in.)
3081A Terminal	1.5 kg (3.3 lb)	2 kg (4.4 lb)	300 mm (12 in.)	180 mm (7 in.)	45 mm (1.8 in.)
92922A Adapter	4.5 kg (10 lb)	5.5 kg (12.1 lb)	145 mm (5.7 in.)	355 mm (14 in.)	215 mm (8.5 in.)
39800A Bar Code	2 kg (4.4 lb)	3 kg (6.6 lb)	71 mm (2.8 in.)	260 mm (10.25 in.)	189 mm (7.4 in.)

CHAPTER 3

Providing Other Necessities

Media Storage
Protection of Valuable Records
Computer Supplies
Telephone

Media Storage

Provide storage for disc cartridges, tape cartridges, and flexible discs in or near the area where work is performed. These items will require a clean, dust-free area. The magnetic media storage environment should be similar to that of the computer (e.g., not exposed to extremes of heat or cold). Extreme humidity or temperature differences in the working and storage areas may alter the size of the media when they are moved from one area to the other. This rapid change results in warping, the most frequent cause of problems.

If working and storage areas cannot be kept at the same relative humidity and temperature, allow ample time (typically one hour or more) for the media to achieve a moisture and temperature balance with the system room atmosphere before using the media. The maximum rate of temperature change for the media must not exceed 20 degrees Celsius per hour.

The data on magnetic media can be erased by magnetic fields, so do not place your magnetic media near such fields. Magnetic fields are found in power generating equipment such as motors, alternators, transformers, and data processing equipment such as disc drives. Hence, do not place disc cartridges, tape cartridges, or flexible discs on top of disc drives.

Protection of Valuable Records

Safety precautions are suggested because the investment represented by the equipment, installation, and data deserves appropriate protection. Safeguards should be taken to protect vital data such as business records, magnetic media, or other information that is either very expensive or impossible to duplicate. Duplicate or master records should be

maintained from which the necessary information can be taken to resume operation quickly in case of an accident. Copies of vital data should be stored well away from the computer area, normally in some type of fireproof storage. A regular updating program is necessary to maintain the value of such duplicate data storage.

Since you are making a valuable investment, you should investigate the possibility of procuring some type of electronic data processing insurance. Various forms can cover both hardware and software.

Computer Supplies

The computer supplies most important to reliable operation of your system are the disc media. HP seeks to provide the best possible total disc performance through extensive testing, selection, and control over all the critical components that make up HP disc products. Understandably, Hewlett-Packard cannot cover warranty for damage sustained by disc drive heads or media when non-HP media are used.

You should order your computer supplies at the time indicated on the Pre-Installation Worksheet (see Appendix A-1). Necessary items for your system include printer ribbon, printer paper, and tape cartridges. Talk with your HP Sales Representative about a complete list of supplies. For information about computer supplies, consult the HP Computer Supplies Catalog.

Telephone

A telephone with a long cord should be located near the HP 250 to allow consultation with the HP Customer Engineer or Systems Engineer about a problem while working on the unit.

CHAPTER 4

When Your System Arrives

Preparation for System Arrival
Coordinated Deliveries
Check for Shipping Damage
Schedule the Installation
Unpack the Cartons
System Installation Day

Preparation for System Arrival

The complete HP 250 Computer System you ordered will be installed by an HP Customer Engineer.

Some preparatory steps are required by you before the actual day of installation. A description of “Coordinated Deliveries” is given below as information so that you know what to expect about equipment arrival. “Check for Shipping Damage” by following the instructions below for a course of action if damage does occur. You should call your local HP Customer Engineering office when you are ready to “Schedule the Installation.” General instructions follow on how to “Unpack the Cartons.” Each carton or crate has its own specific instructions for unpacking. On “System Installation Day,” the HP Customer Engineer checks and verifies the computer site environment, turns on the power and runs diagnostics, installs the HP 250 system software, and ensures that the complete system is operating properly.

Coordinated Deliveries

Peripheral equipment made by Hewlett-Packard for the HP 250 is delivered directly to you from the location at which it is made. Hewlett-Packard coordinates the shipment of equipment from all locations so that all of your order arrives at approximately the same time. In some cases, factors beyond the control of Hewlett-Packard may cause delivery dates to vary. If you do not receive your entire order within a two-week period, notify the local HP Sales Representative, who will trace your order and complete delivery.

Check for Shipping Damage

As each shipment arrives, check the carrier’s “Bill of Lading” carefully to make sure that every item shipped by HP has been delivered. If there are missing items, notify the carrier immediately.

Before unpacking any equipment, inspect all containers for signs of damage that might have occurred during shipment. Some typical signs of shipping damage are dents, scratches or cuts, or water marks. If any damage is found, note on the bill of lading that there is “Apparent damage—subject to inspection” and arrange for both the carrier’s representative and the local HP Customer Engineer to be present when that item is unpacked.

Regardless of the circumstances, the HP Customer Engineer will take immediate action to replace any damaged parts without waiting for the settlement of claims.

Schedule the Installation

Once your complete system has been delivered, call the local HP sales and service office to set an installation date. On this date, your HP Customer Engineer installs your system.

Unpack the Cartons

The cartons can be unpacked whenever it is convenient for you to do so; however, it is preferable to unpack the system on the day of installation. The HP Customer Engineer will

supervise the unpacking to assure that all individual system components have been shipped. (The system installation cannot be performed until the complete system has arrived.) Instructions for unpacking the cartons are shipped with the HP 250 and each of its peripherals; unpacking instructions are attached to the outside of the cartons.

Locate the packing list (invoice) for each carton or crate that you unpack and ascertain that you have received every item on the packing list. If something is missing, contact your HP Sales Representative immediately.

System Installation Day

On the installation day, your HP Customer Engineer performs the verification and installation. He or she

- Visually inspects all system components.
 - Interconnects the HP products.
 - Performs turn-on procedures and makes all electronic and mechanical adjustments.
 - Executes standard HP diagnostics and tests.
 - Demonstrates how to start up and power down the system.
 - Explains back-up procedures, preventive maintenance, and printer operation.
-
- Verifies that the site has been prepared according to the Guide.

APPENDIX A

HP 250 Pre-Installation Worksheet
HP 250 Space Planning Kit
Site Completion Checklist

HP 250 Pre-Installation Worksheet

Pre-Installation Activities

Timing	Activity	Date
6 weeks Before Installation	<p>Select the location for your HP 250. Use the Site Preparation Guide and Checklist to satisfy the physical requirements and to ensure that the site is ready when your HP 250 arrives.</p> <p>Assign a person to assume responsibility as the HP 250 Principal Operator.</p> <p>Plan the physical arrangement of your HP 250 and its supporting furniture. The Space Planning Kit allows you to plan the details before your system arrives.</p> <p>Order supplies that will be required for uninterrupted operation of your HP 250 (printer paper and ribbons, flexible discs, tape cartridges, disc pack, etc.).</p>	
2 weeks Before Installation	<p>Schedule a date for the installation of your HP 250 with the local HP Customer Engineer. The date can be tentative based on the delivery dates received from HP or the companies transporting your equipment.</p>	
At System Delivery	<p>Inspect each shipment as it is delivered. Note dates and comments in the Shipment Schedule (A-2). Notify the HP Customer Engineer when your complete order has been delivered.</p>	
System Installation	<p>Arrange for the Principal Operator to be present to assist and advise the Customer Engineer throughout the installation process. After the computer is installed and tested, the CE will help make your computer operational by providing instruction and assistance.</p>	
Comments		

HP 250 Pre-Installation Worksheet (continued)

Shipment Schedule

Equipment Name	Scheduled Ship Date	Arrival Date	Comments
HP 250 System Unit			
Printer			
Terminal			
Workstation			
Disc Drive			
Plotter			
Data Capture Terminal			
Bar Code Reader			

HP 250 Space Planning Kit

top views of the system components (see A-5) are drawn to scale and can be used for designing the floor plan of your HP 250. When cut out and used on a scale drawing of your computer site, the models can be moved about to help determine the best room arrangement. The next page is a sheet of grid paper drawn to the same scale. It can be used to prepare the scale drawing of your proposed HP 250 site.

Instructions

1. On the grid sheet, draw the room (walls, electrical outlets, immovable objects, etc.) in which you plan to locate the HP 250. The
2. Cut out the models required to represent the HP 250 system that you ordered. Include the office furniture that you will use.
3. Move the models of your system about on the grid to determine the best room arrangement. (Don't forget to allow room for maintenance in front and back of system and disc[s].)
4. Cabling is required between the HP 250 and each peripheral. Mark each cable's path and indicate its necessary length.

Space Planning Grid Sheet

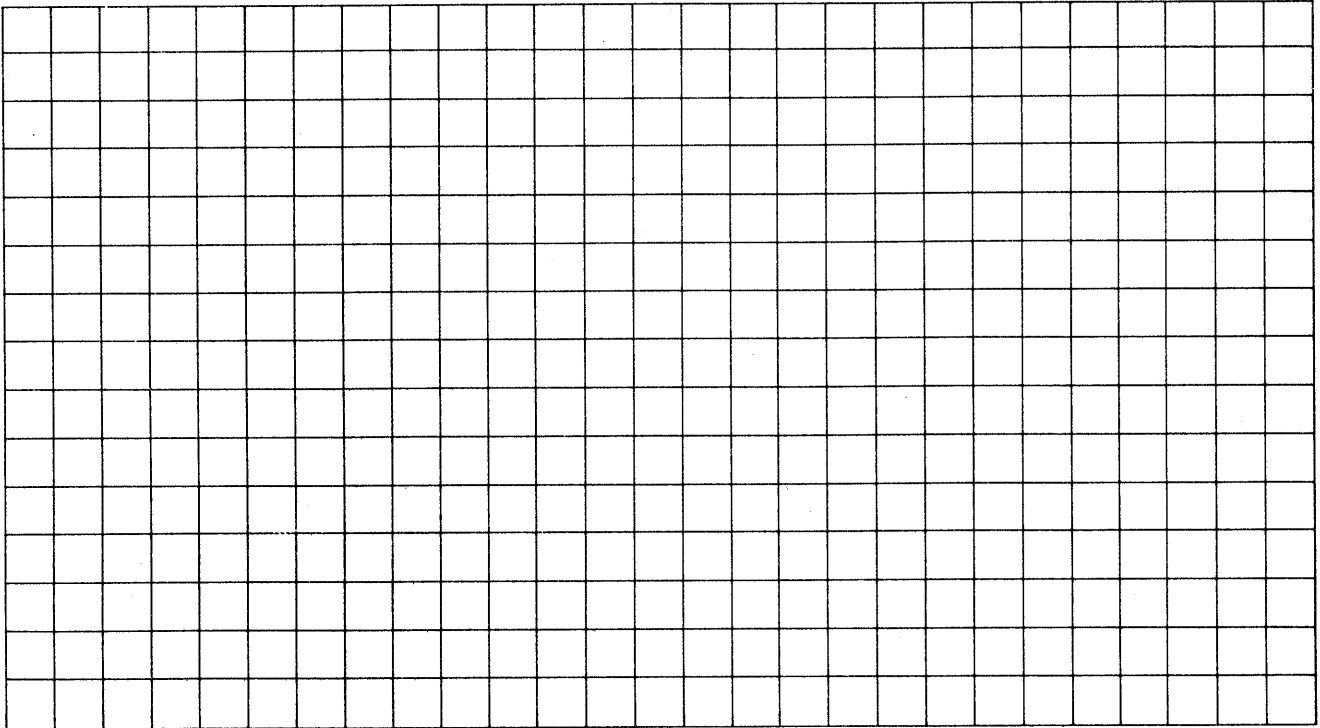

($\frac{1}{4}$ in. = 1 ft.)

(6.35 mm = 304.8 mm)

Cut out the models required to represent the HP 250 system that you ordered. Include the office furniture that you will use.

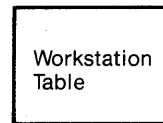
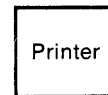
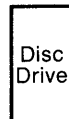
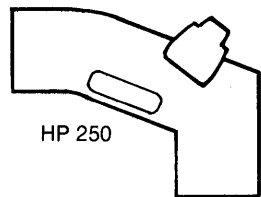

HP 250
with
Workstation
Table

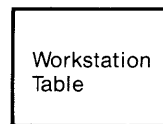
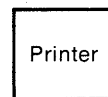
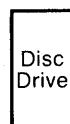
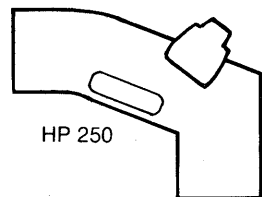
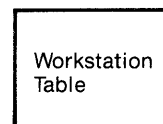
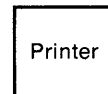
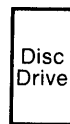
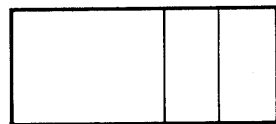

HP 250
with
Workstation
Table

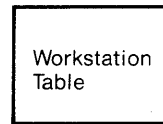
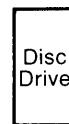
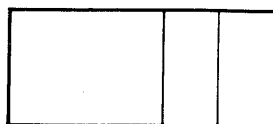

Site Completion Checklist

This checklist can be used to monitor the status of any work needed on the site selected for your HP 250. Requirements are listed first. These items must be completed before the HP 250 can be installed by the HP Customer Engineer. The

additional items are not requirements, however, they are considerations which should not be overlooked when planning and preparing the site for your HP 250.

	Work Required	Work Scheduled	Work in Progress	Completed
Items Required Before Installation				
The size of the site meets the requirements of the system ordered. (Size requirements can be determined with the "HP 250 Space Planning Kit.")				
The electrical power required is available and the wall outlets are in the proper locations.				
All wall outlets are properly grounded.				
Separate circuit breakers of the proper rating are installed.				
Modems and RS-232 extension cables are installed.				
The temperature is within the required operating range.				
If required, air conditioning equipment is installed and operating.				
The humidity is within the required operating range.				
If required, humidifiers/dehumidifiers are installed and operating.				
Additional Items to Be Considered				
The storage area for system supplies is complete.				
The furniture for users of the system is available at the site.				
A telephone is installed at the site.				
If the site is carpeted, anti-static measures have been taken.				
Additional wall outlets for office equipment and janitorial maintenance are installed (separate circuits from the HP 250 system).				

