

SPECIAL SYSTEMS

CONTROL DATA® 6676-A TTY MULTIPLEXER

DESCRIPTION  
OPERATION  
PROGRAMMING

REFERENCE MANUAL

**CONTROL DATA**  
CORPORATION

**SPECIAL SYSTEMS**

**CONTROL DATA® 6676-A TTY MULTIPLEXER**

**DESCRIPTION  
OPERATION  
PROGRAMMING**

**REFERENCE MANUAL**

**CONTROL DATA  
CORPORATION**



## PREFACE

This manual gives the programming codes and operating characteristics of the 6676-A TTY Multiplexer. It is assumed that the reader is acquainted with programming (especially I/O formats) and operating characteristics of the 6000 Series computer system (see 6400/6500/6600 Computer Systems Reference Manual). This manual does not contain hardware information. The following Control Data publications contain hardware maintenance information for the 6676-A TTY Multiplexer.

<u>Title</u>	<u>Publication Number</u>
6676-A TTY Multiplexer Customer Engineering Manual	38708400
Input/Output Specifications Manual	60045100



# CONTENTS

<u>Section</u>	<u>Title</u>	<u>Page</u>
1 . . . . .	INTRODUCTION . . . . .	1-1
	Data Transfer Rate . . . . .	1-2
	Capabilities . . . . .	1-2
	Data Transfer Mode . . . . .	1-2
	Dual Channel Control . . . . .	1-2
	Modem Capability . . . . .	1-2
2 . . . . .	DESCRIPTION AND OPERATION . . . . .	2-1
	Physical Description . . . . .	2-1
	Functional Description . . . . .	2-1
	Data Channel ↔ Multiplexer . . . . .	2-1
	Multiplexer ↔ Modem Terminals . . . . .	2-3
	Memory . . . . .	2-3
	Function Control . . . . .	2-3
	Output . . . . .	2-4
	Input . . . . .	2-4
	Status . . . . .	2-5
	Operation . . . . .	2-5
	Controls and Indicators . . . . .	2-6
	Cabinet Controls and Indicators . . . . .	2-6
	Control Panel . . . . .	2-7
3 . . . . .	PROGRAMMING . . . . .	3-1
	Function Select Codes . . . . .	3-1
	Select Output (X001) . . . . .	3-1
	Status Request (X002) . . . . .	3-1
	Select Input (X003) . . . . .	3-2
	Word Formats . . . . .	3-2
	Output Word Format . . . . .	3-2
	Input Word Format . . . . .	3-3
	Status Word Format . . . . .	3-4
	Programming Considerations . . . . .	3-5
	Status . . . . .	3-5
	Output Status Check . . . . .	3-6
	Data Block Length . . . . .	3-6

## CONTENTS (Cont'd)

<u>Section</u>	<u>Title</u>	<u>Page</u>
3	Output Timing . . . . .	3-6
	Input Timing . . . . .	3-6
	I/O Operation . . . . .	3-7
	Programming Example . . . . .	3-7
	Symbol Data . . . . .	3-8
4 . . . . .	OPTIONAL INTERFACE INFORMATION . . . . .	4-1
	Description and Operation . . . . .	4-1
	Programming . . . . .	4-1
	Function Select Codes . . . . .	4-1
	Status . . . . .	4-2

## FIGURES

<u>Figure</u>	<u>Title</u>	<u>Page</u>
1-1 . . . . .	Typical 6000 Series Computer/6676-A Relationship . . . . .	1-1
2-1 . . . . .	Multiplexer Block Diagram . . . . .	2-2
2-2 . . . . .	Single Access Multiplexer Control Panel . . . . .	2-7
2-3 . . . . .	6676-A Switch Panel . . . . .	2-8
3-1 . . . . .	Output Word Format . . . . .	3-2
3-2 . . . . .	Input Word Format . . . . .	3-3
3-3 . . . . .	Status Word Format . . . . .	3-5
3-4 . . . . .	Sample Multiplexer Servicing Routine . . . . .	3-7
4-1 . . . . .	6000/Dual Channel 6676 Relationship . . . . .	4-1
4-2 . . . . .	Dual Access Multiplexer Status Response Word . . . . .	4-2

## TABLES

<u>Table</u>	<u>Title</u>	<u>Page</u>
3-1 . . . . .	Multiplexer Function Codes . . . . .	3-1
3-2 . . . . .	I/O Control Octal Codes . . . . .	3-3
3-3 . . . . .	ASCII Character Set . . . . .	3-8
4-1 . . . . .	Dual Access Multiplexer Function Codes . . . . .	4-2

## SECTION 1

# INTRODUCTION

The CONTROL DATA® 6676-A TTY Multiplexer can interface with as many as 64 low-speed remote terminals (i. e. , 110 bits per second or 110 Baud) to a Control Data 6000 Series computer system. The multiplexer is designed for remote terminal communications with a large central computing facility. The multiplexer and its software package allow an immediate contact between the terminal and the computer. This permits maximum on-line access to the central computing facility. The user can then write routines, debug programs, establish files, or modify existing data from the remote terminal any time he chooses, without requesting scheduled time at the central facility. The remote terminal may be located adjacent to the computer or several thousand miles away, wherever a telephone line connection is available.

Figure 1-1 illustrates a remote system utilizing teletypewriters. This remote system consists of a 6676-A plus its modems (DATA PHONE\* Data Set 103), interfacing as many as 64 ASR-33 Teletypes or code-compatible remote terminals to a 6000 Series data channel.

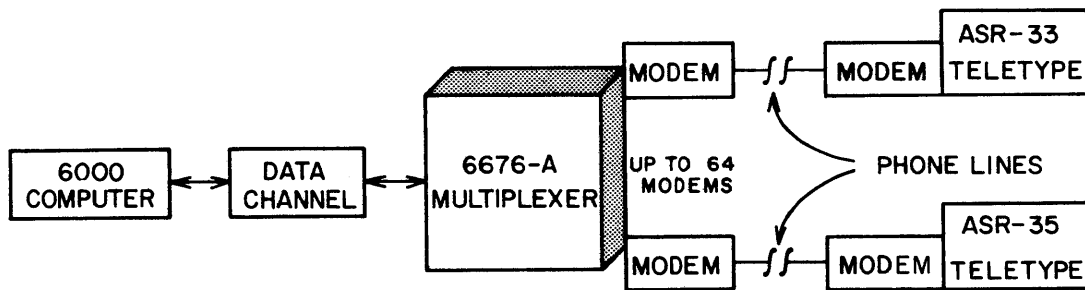

Figure 1-1. Typical 6000 Series Computer/6676-A Relationship

\*Registered trademark of Bell System.



## **DATA TRANSFER RATE**

The 12-bit data word transmission between the data channel and the multiplexer is at a 1MHz rate. This rate permits input/output of a 64-word block in 64  $\mu$ sec. The eight-data-bit serial character transmission, plus data control pulses, between the multiplexer and the terminal, is 110 bits per second or 110 Baud. These speeds are such that, with a terminal active, the multiplexer requires an input operation every 100 ms (110 Baud) or 18 ms (600 Baud) or Lost Data may occur. Because of the terminal I/O rate, the multiplexer can tolerate a maximum of 100 ms (110 Baud) or 18 ms (600 Baud) between sequential output data blocks. An option kit, available on an individual quotation basis, provides replacement of the 600 Baud speed with another speed up to 1400 Baud and either a 10- or 11-bit character length.

## **CAPABILITIES**

### **DATA TRANSFER MODE**

The multiplexer can operate in half-duplex mode, full-duplex mode, or both simultaneously. In half-duplex mode (two-wire operation), data transfer between the multiplexer and the terminals proceeds in only one direction (either receive or transmit) at a time. In full-duplex mode (four-wire operation), data transfer between the multiplexer and the terminals can proceed in both directions simultaneously.

### **DUAL CHANNEL CONTROL**

An optional interface (available on an individual quotation basis), permits control by a second 6000 Series data channel. This second data channel can be from the same computer system or from a completely separate computer system. Section 4 of this manual describes programming changes for the optional interface.

### **MODEM COMPATIBILITY**

The 6676-A TTY Multiplexer is capable of operating with the DATA PHONE Data Sets 103A2, 103F2, and 202C, or compatible modems. A special controller (available on an individual quotation basis), permits the use of the DATA PHONE Data Auxiliary Set 801 for automatic dialing of data set connections from the computer end. The modems may be replaced by either of two special interfaces: 1) a special coupler combination to connect TTY directly to the 6676-A for TTY's within 50 feet of the multiplexer, and 2) a Teletype Loop Adapter to provide teletype loops for transmission of data up to 20 miles. Both of these special interfaces are available on an individual quotation basis.

## SECTION 2

### DESCRIPTION AND OPERATION

#### PHYSICAL DESCRIPTION

The multiplexer is contained in a standard Control Data Type B cabinet and can be installed in any area that meets 6000 Series computer requirements. No environmental restrictions other than normal cleanliness, air circulation, and accessibility are necessary.

##### Cabinet Dimensions

Height	56-7/8 inches
Width	42 inches
Depth	20-1/2 inches

##### Cabinet Weight

850 pounds

##### Cabinet Power

Requirements	400 Hz, 208 volts, 3-phase, 925 VA
	60 Hz, 120 volts, 1-phase, 209 VA

##### Cabinet Cooling

Requirements	3620 BTU/hr
Operating Temperature	60° to 80° F

#### FUNCTIONAL DESCRIPTION

Figure 2-1 is a functional block diagram of the multiplexer. The block diagram shows the lines that connect the data channel and the multiplexer, and major circuits of the multiplexer.

##### DATA CHANNEL ↔ MULTIPLEXER

Data transfer between the data channel and the multiplexer must be via data blocks. These blocks contain from one to sixty-four 12-bit data words. Each 12-bit data word may contain a data character in the lower eight bits, while the remaining four bits contain I/O control bits or unused bits. During output operations, the programmer must generate the I/O control bits; during input operations the multiplexer generates the operation control status bits.

Figure 2-1. Multiplexer Block Diagram

2-2

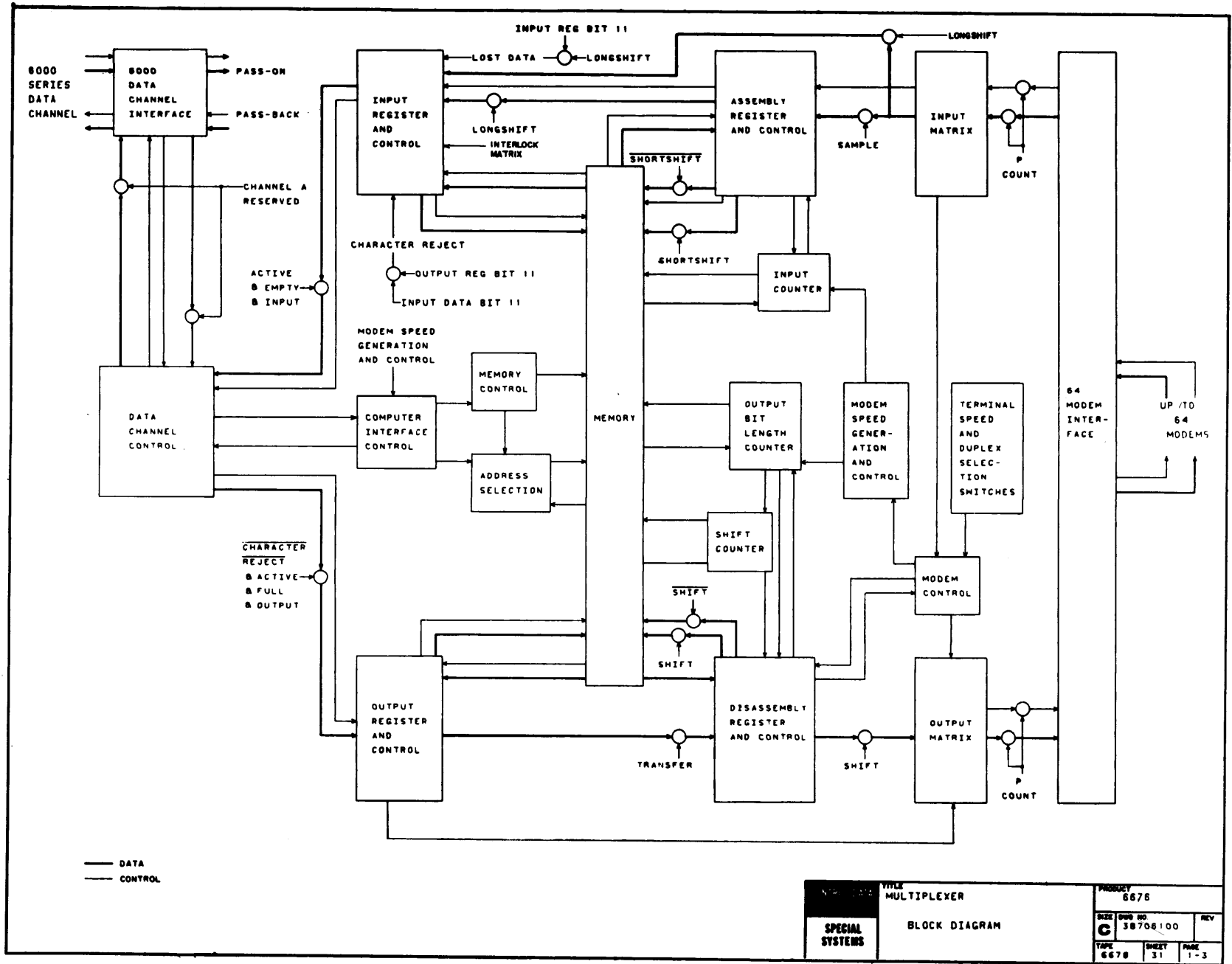

— DATA  
- - - CONTROL

<b>SPECIAL SYSTEMS</b>	TITLE <b>MULTIPLEXER</b>	PRODUCT <b>6676</b>
	BLOCK DIAGRAM	SIZE: 38708100
		REV: C
	TYPE: 6676	SHEET: 31
		PAGE: 1-3

## MULTIPLEXER ↔ MODEM TERMINALS

Data transfer between the multiplexer and modem terminals is via serial 8-bit characters plus start and stop bits for each character. The multiplexer associates each data word in the data block with one of the 64 terminals. The multiplexer transfers data word 0 to and from terminal 0, data word 1 to and from terminal 1, and so on. This format applies regardless of the number of terminals available or requiring service.

## MEMORY

The multiplexer utilizes a 64-word, 56-bit core storage memory for buffering data to and from the data channel and terminals. The memory word bits are divided into six sections:

1. Output buffer
2. Serial output disassembly
3. Control
4. Serial input assembly
5. Input buffer
6. I/O status

Each memory word is assigned to a particular terminal. Memory word 0 receives data words from and for terminal 0, memory word 1 from and for terminal 1, and so on. The buffered memory allows the multiplexer to output to some terminals, and simultaneously receive input from other terminals or the same terminal. For example, the output disassembly memory section can be performing an output to terminals 0 through 10, and the input assembly memory can be performing an input from terminals 60 to 63, while both input and output operations are being performed on terminals 30 to 42.

## FUNCTION CONTROL

To initiate data transfer with a remote terminal, the Peripheral Processor Unit (PPU) must select the multiplexer via a function select code. A function select code contains an Equipment code and a Function code which designate equipment and multiplexer operating modes. Upon receipt of a function code, the multiplexer generates an Inactive signal to the computer and enables the operating mode requested. Upon successfully selecting the multiplexer and an operating mode, the multiplexer is ready for an input, output, or status operation.

## OUTPUT

Upon successfully selecting output mode via a function select code, the PPU activates the multiplexer's data channel and transfers a block of data words to the multiplexer. The multiplexer stores the data block in its output buffer memory section. After completing the block storage, the multiplexer prepares the terminals which require an output for a transmit operation.

Upon receipt of a signal indicating terminal readiness, the multiplexer begins a memory transfer. The memory transfer consists of transferring the lower eight bits (data character) and bit 11 for each terminal from the output buffer section to the output disassembly section, provided the disassembly section of the terminal is empty. If the disassembly section is not empty, the transfer for that terminal must wait for a later memory cycle. During this memory transfer, the multiplexer also transfers a start bit to the terminal if bit 11 (Output Required) is set.

Following the start bit transmission, the multiplexer begins serial bit transmission of the character. This operation consists of transmitting a bit to each terminal before the next bit is transmitted. A character for a terminal is first read from the disassembly memory section. Then the multiplexer shifts the highest-order bit to the modem and left-shifts the remaining bits as it writes them back into the disassembly memory section. The multiplexer continues this shift for each of the terminals and appends the two stop bits to the character.

The multiplexer is ready for another data block after transferring the previous data block from the output section to the output disassembly section. The multiplexer can store a data block in the output memory section while the preceding data block is in the output disassembly memory section. If the multiplexer receives a data word for a terminal when the output memory section of the terminal is full, the multiplexer performs a pseudo-accept of the new data word and sets the Character Reject status bit. (A pseudo-accept will not allow a new word to destroy the word presently stored in memory.)

## INPUT

Upon successfully selecting input mode via a function code, the PPU activates the multiplexer channel. Upon receipt of the Active signal, the multiplexer immediately transfers the first word of the data block from the input memory section to the Data Channel. The data block contains as many as sixty-four 12-bit words which contain

an eight-bit data character and the I/O status bits for each active terminal. Prior to the block transfer, the multiplexer performs an assembly operation with the active terminals.

The assembly operation consists of assembling the serial data bits from the active terminals and storing the data characters in memory. The assembly section scans for a bit from each terminal before scanning for the next bit. When a character assembly for a specific terminal is completed, the multiplexer transfers that portion of the assembly section to the lower eight bits of the input buffer section of that terminal and sets bit 11 of the input buffer section. The assembly section continues assembling and transferring characters as long as serial data from the terminals is available (even if the input memory section contains data).

If the multiplexer completes assembly of a data character when the input memory of the terminal section is full, the multiplexer writes the new data character into memory (destroying the previous character) and sets the Lost Data I/O control bit.

Upon receipt of an input function selection followed by an Active signal, the multiplexer transfers as much as a 64-word data block from the input memory section to the data channel. The block may contain assembled data characters and characters containing zeros. The zero-containing characters may have the I/O status bit set. Valid data characters are detected by examining bit 11 of each input data word.

## STATUS

Upon successfully selecting status mode via a function code, the PPU activates the multiplexer channel. Upon receipt of the Active signal, the multiplexer immediately transfers one 12-bit status word to the data channel.

## OPERATION

The multiplexer is entirely program-controlled, and requires no operator intervention during normal operation. Ordinarily, multiplexer power is on when system power is on. However, multiplexer power can be turned off or on at any time by using the Circuit Breaker 1 (CB1) switch in the cabinet.

## **CONTROLS AND INDICATORS**

The multiplexer controls and indicators consist of the cabinet controls and indicators and those on the multiplexer control panel.

### **CABINET CONTROLS AND INDICATORS**

#### Circuit Breaker Indicator

The Circuit Breaker indicator will light when the 400 Hz circuit breaker trips or when it is in Off position.

#### Thermostat Bypass Indicator

The Thermostat Bypass indicator will light when the Thermostat Bypass switch is in On position.

#### Temperature Warning Indicator

The Temperature Warning indicator will light when air temperature entering the cabinet exceeds 80°, when a blower fails, or a blower does not provide sufficient air.

#### High Temperature Indicator

The High Temperature indicators will light when air temperature in the cabinet exceeds 110°. The 400 Hz circuit breaker trips when the High Temperature indicator lights.

#### CB1 Switch

The CB1 switch turns on 400 Hz power to the power supply. In Off position the Circuit Breaker indicator is lit.

#### Thermostat Bypass Switch

The Thermostat Bypass switch will light the Thermostat Bypass indicator and bypass the equipment's thermal protection.

### CAUTION

With the Thermostat Bypass switch in On position, the multiplexer does not have thermal protection. It is recommended that the multiplexer be operated in this condition only in an emergency.

## CONTROL PANEL

Figure 2-2 illustrates the multiplexer control panel.

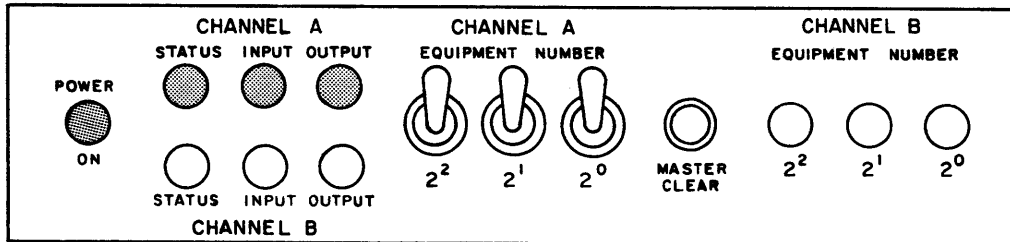

Figure 2-2. Single Access Multiplexer Control Panel

### NOTE

Indicator lights and equipment select switches for the second channel (B) are provided for but not installed.

#### Equipment Number Switches

The Equipment Number switches determine the equipment number which the multiplexer recognizes.

#### Master Clear Switch

The Master Clear switch generates a clear pulse to the multiplexer circuits and memory. This switch should not be used when the multiplexer is under program control because the PPU will fault.

#### Select Status Indicator\*

The Select Status indicator will light upon receipt of a Select Status Request (X002) function code.

#### Select Input Indicator\*

The Select Input indicator will light upon receipt of a Select Input (X003) function code.

#### Select Output Indicator\*

The Select Output indicator will light upon receipt of a Select Output (X001) function code.

\*Note: These operations are normally performed too fast for these indicators to light. However, they will light if the multiplexer faults in any of these operations.



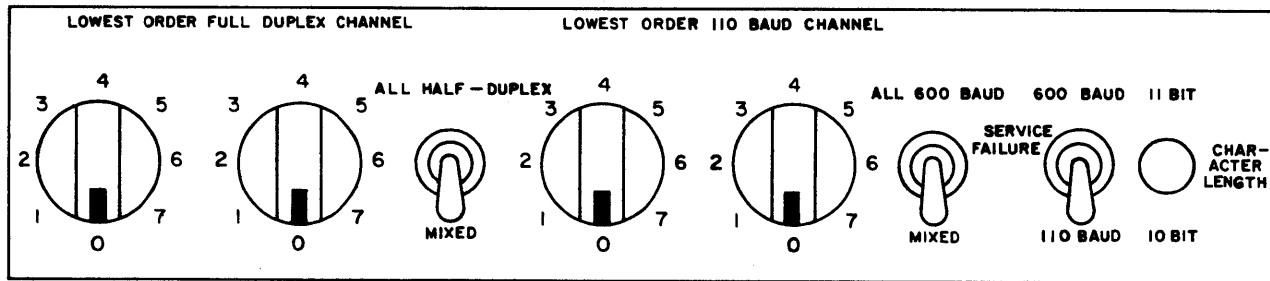

Figure 2-3. 6676-A Switch Panel

Half Duplex/Mixed Switch

The Half Duplex/Mixed switch (located on the back of the chassis) in the Half Duplex position, indicates that the terminal interfaces are all half-duplex. In the Mixed position, it indicates that some or all of the terminal interfaces are full-duplex. The Full Duplex Select switches designate which interfaces are in full-duplex mode.

Full Duplex Select Switches

The Full Duplex Select switches (located on the back of the chassis) designate the terminal interfaces which are in the full-duplex mode. The switches designate the first full duplex terminal. For example, if there are 16<sub>8</sub> terminals available, and seven of these terminals are full-duplex, the Full Duplex Select switches must be set to 11<sub>8</sub>.

600 Baud/Mixed Switch

The 600 Baud/Mixed switch (located on the back of the chassis) in the 600 Baud position, indicates that all the terminals operate at 600 Baud. In the Mixed position, the switch indicates that all or some of the terminals operate at 110 Baud. The 110 Baud Select switches designate which terminals operate at 110 Baud.

110 Baud Select Switches

The 110 Baud Select switches (located on the back of the chassis) designate the terminals which operate at 110 Baud. The switches designate the first 110 Baud terminal. For example, if there are 16<sub>8</sub> terminals available, and seven of these terminals are 110 Baud, the 110 Baud Select switches must be set to 11<sub>8</sub>.

### Service Failure Switch

The Service Failure switch determines the speed of the Input Required and Service Failure status bits. In the 110 Baud position, these bits are based on a 100 ms character time. In the 600 Baud position, these bits are based on eleven bit times of the particular Baud speed used.

### Character Length Switch

When installed, the Character Length switch determines whether the terminals designated as 600 Baud use a 1-bit time or a 2-bit time stop pulse. The 110 Baud terminals remain a 2-bit time stop pulse.



## SECTION 3 PROGRAMMING

### FUNCTION SELECT CODES

Function select codes recognized by the multiplexer will select the multiplexer and initiate one of three operating modes. Table 3-1 contains a short description of function codes. The X prefix of each function select code must coincide with the Equipment Select switch settings. Function code selection does not disable the multiplexer from transferring output data characters from memory to the terminals, or input data characters from the terminals to memory.

TABLE 3-1. MULTIPLEXER FUNCTION CODES

Octal Codes	Description
X001	Select Output
X002	Select Status Request
X003	Select Input

Upon receipt of a function code, the multiplexer generates an Inactive to the PPU when bits 9 through 11 of the function code correspond to the setting of the Equipment Select switch. The multiplexer does not respond when the above condition is not present (e. g. , function codes bits 9 through 11 do not match Equipment Select switch setting). After generating an Inactive, the multiplexer enables the selected operating mode (i. e. , Output, Status Request, or Input), but does not start the operation until the PPU generates an Active signal on the data channel.

#### SELECT OUTPUT (X001)

Receipt of a Select Output function code (X001) enables the multiplexer to accept a data block from the data channel. This data block can contain a maximum of 64 data words. (See word format descriptions following, for a sample of an output word.)

#### STATUS REQUEST (X002)

Upon receipt of a Status Request function code (X002), the multiplexer transfers a 12-bit status word to the data channel input lines. This Status Request function code must be followed by an input operation in order to examine the status bits. (See word format descriptions following, for specific bit assignments of the status word.)

### SELECT INPUT (X003)

Receipt of a Select Input function code (X003) enables the multiplexer to transfer a data block to the data channel. Receipt of an Active (Activate Channel instruction) enables the multiplexer to immediately transfer a data block to the data channel.

## WORD FORMATS

The multiplexer communicates with the PPU via a 12-bit data word. A 12-bit data word either contains an 8-bit character (which the multiplexer receives from or transfers to the terminal) and control bits (which indicate input/output conditions within the multiplexer) or status bits, as is the case with a status word.

### OUTPUT WORD FORMAT

Figure 3-1 illustrates the output word format required by the multiplexer during data transfers with the Data Channel.

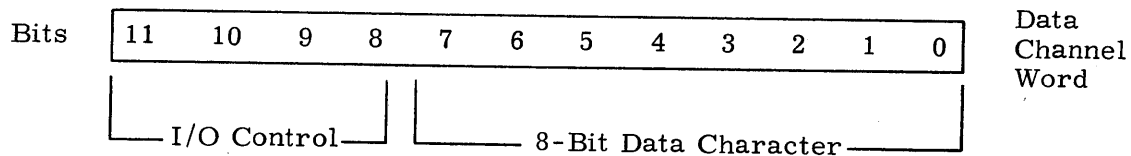

Figure 3-1. Output Word Format

### Eight-Bit Data Character (4XXX)

Bits 0 through 7 of the data channel word contain the 8-bit character. When enabled, the multiplexer performs a serial transfer of the 8-bit character (bit 1 first) to the modem terminal. Bit 0, when used, is transferred last as the parity bit.

### I/O Control

Bits 8 through 11 of the data channel word are I/O control bits. These bits, in various combinations, act as a flag for data characters or disconnect the modem. Table 3-2 gives a short description of each octal code. Note that only Output Required (4XXX) can contain a data character in the lower eight bits of the data channel word.

TABLE 3-2. I/O CONTROL OCTAL CODES

Octal Codes	Description
6000	Disconnect Modem
0XXX	No Operation
4XXX	Output Required
All Other Codes	Do Not Use

Disconnect Modem (6000): Bits 10 and 11 of a data channel word, when set, enable termination of data connection between the multiplexer and the remote terminal. The programmer should set bits 10 and 11 of a data channel word to deactivate a terminal.

NOTE

The data word which utilizes this disconnect feature should not contain a data character, as the data transfer terminates and that data character is lost.

Output Required (4XXX): Bit 11 of a data channel word, when set, indicates bits 0 through 7 of the word contain a data character. The programmer should set this bit when the multiplexer is to transfer a data character to the modem.

All Other Codes: The multiplexer ignores all codes not having bit  $2^{11}$  set and advances to the next word. Codes having bit  $2^{11}$  set will be treated as either a 6000 or a 4XXX and should not be used.

INPUT WORD FORMAT

Figure 3-2 illustrates the input word format utilized by the multiplexer during data transfer with the data channel.

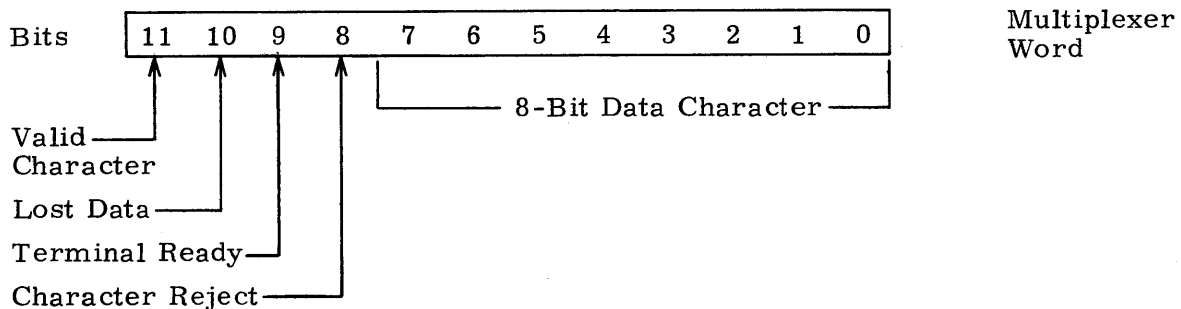

Figure 3-2. Input Word Format

### Eight-Bit Data Character

Bits 0 through 7 of the multiplexer word contain the 8-bit data character. The multiplexer assembles the character from serial data (bit 1 first) received from the modem. Bit 0, when used, is transferred last as the parity bit.

### Character Reject

Bit 8 of the multiplexer word, when set, indicates the multiplexer did not accept an output data word because memory was full. This control bit sets if a data channel output word was pseudo-accepted and discarded because the output buffer memory for that terminal was full. The multiplexer clears this control bit after transferring the input word to the PPU.

### Terminal Ready

Bit 9 of a multiplexer word, when set, indicates a connection exists between the terminal and modem; i. e., the modem Interlock signal is present. This control bit is clear when a terminal is deactivated.

### Lost Data

Bit 10 of a multiplexer word, when set, indicates the PPU failed to perform an input operation within the prescribed time limit; therefore, one or more data words were lost. When a terminal is active, the PPU must perform an input operation within 5 ms after Input Required (status bit 1) sets. The multiplexer clears this control bit when transferring the input word to the PPU.

### Valid Character

Bit 11 of an input word, when set, indicates bits 0 through 7 contain a data character. The multiplexer sets this bit after assembling a complete data character from an active terminal.

## STATUS WORD FORMAT

Status provides a means by which the PPU can determine the condition of the multiplexer. To determine the multiplexer status, the PPU issues a Status Request function select code (X002), followed by an input operation. Figure 3-3 gives the format of the multiplexer status response word.

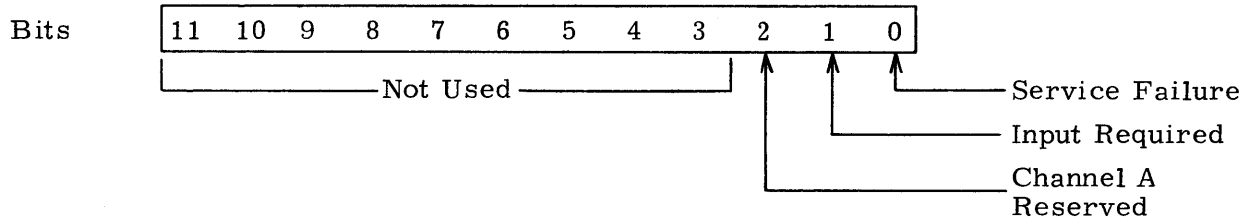

Figure 3-3. Status Word Format

Service Failure (0001)

Status bit 0 sets when the PPU fails to perform an input operation within 95 percent of a character time after Input Required (status bit 1) sets. Service Failure does not indicate that any data has been lost, but indicates the possibility of Lost Data. The multiplexer clears status bit 0 upon receipt of a Select Input function code.

Input Required (0002)

The multiplexer requests an input operation when status bit 1 is set. The Input Required (0002) status bit is a clock function which sets when 95 percent of a character time has elapsed. The character rate of the Service Failure switch setting determines the period of the clock. The input operation requested by the status bit should follow within 5 percent of a character time or Lost Data may occur. The Service Failure switch should be set to the speed of the fastest modem used.

Channel A Reserved (0004)

The multiplexer is reserved by PPU A when status bit 2 is set. In a single-access multiplexer system, this status bit is always set. If the multiplexer has the optional Dual Access Interface, this status bit sets when channel A has control of the multiplexer.

**PROGRAMMING CONSIDERATIONS**

STATUS

The multiplexer has two types of status available: equipment status via a Status Request function code; and operation control status via the input data words. The equipment status consists of Service Failure and Input Required. The operation status consists of Valid Character, Lost Data, and Terminal Ready indications for input operations, as well as Character Rejected indications for output operations.



## OUTPUT STATUS CHECK

To obtain complete status of an output operation, an input operation must follow the output operation. The terminal for which an output character has been rejected will have bit 8 set in the next input word from that terminal; e. g., when an output character to terminal 10 (word 10 of the output block) is rejected, the next input block will have bit 8 set in word 10.

## DATA BLOCK LENGTH

For multiplexer installations which control less than 64 terminals, the input/output data block length can be a function of the terminals available. For example, if a multiplexer only controls 16 terminals, the I/O data blocks need only be 16 words if the terminals are consecutively numbered starting with terminal 0. However, the data block must be of sufficient size to accommodate all terminals in the system or Lost Data will occur; i. e., it is impossible to work with ten terminals if the system has thirty. The multiplexer considers all data transfers to start at terminal 0.

## OUTPUT TIMING

The multiplexer is capable of accepting a 64-word output data block from the Data Channel in  $64 \mu\text{sec}$  ( $1 \mu\text{sec}/\text{word}$ ). The complete output, including disassembly and transfer, requires an additional 100 ms. If the multiplexer receives a new data word before the preceding word is transferred to the disassembly section, the new word is lost and Character Rejected (bit 8) sets in the next input word. Because of these output timing restrictions, each output block should be followed by an input block in which bit 8 of the input data words is checked.

## INPUT TIMING

The multiplexer is capable of transmitting a 64-word data block to the Data Channel in  $64 \mu\text{sec}$  ( $1 \mu\text{sec}/\text{word}$ ). The time required for the multiplexer to assemble a complete input code from a terminal is 100 ms for 100 Baud or one character time at the terminal speed. After assembling a character, the multiplexer transfers it to the input buffer section.

With a word assembled and status bit 1 set (status bit 1 is a clock that sets when 95 percent of a character time has elapsed), an input from the data channel must be activated within 5 percent of a character time or the word may be lost. This results in Lost Data for the corresponding word.

## I/O OPERATION

A PPU I/O operation will suspend terminal servicing operations that commence with the Activate Channel instruction. The Disconnect Channel instruction completes the I/O operation. It is essential that the I/O operation be kept as short as possible. After an input or output operation, the channel must disconnect before any further operations can take place.

### PROGRAMMING EXAMPLE

Figure 3-4 is a flow chart of a multiplexer servicing routine. The sample program is included as an aid to understanding the multiplexer operations. Programming the multiplexer is similar to programming other peripheral equipment. A typical order of programming steps is:

1. Status (determine if multiplexer requires service)
2. Output (output data to terminals)
3. Input (input data plus I/O control bits for terminals)

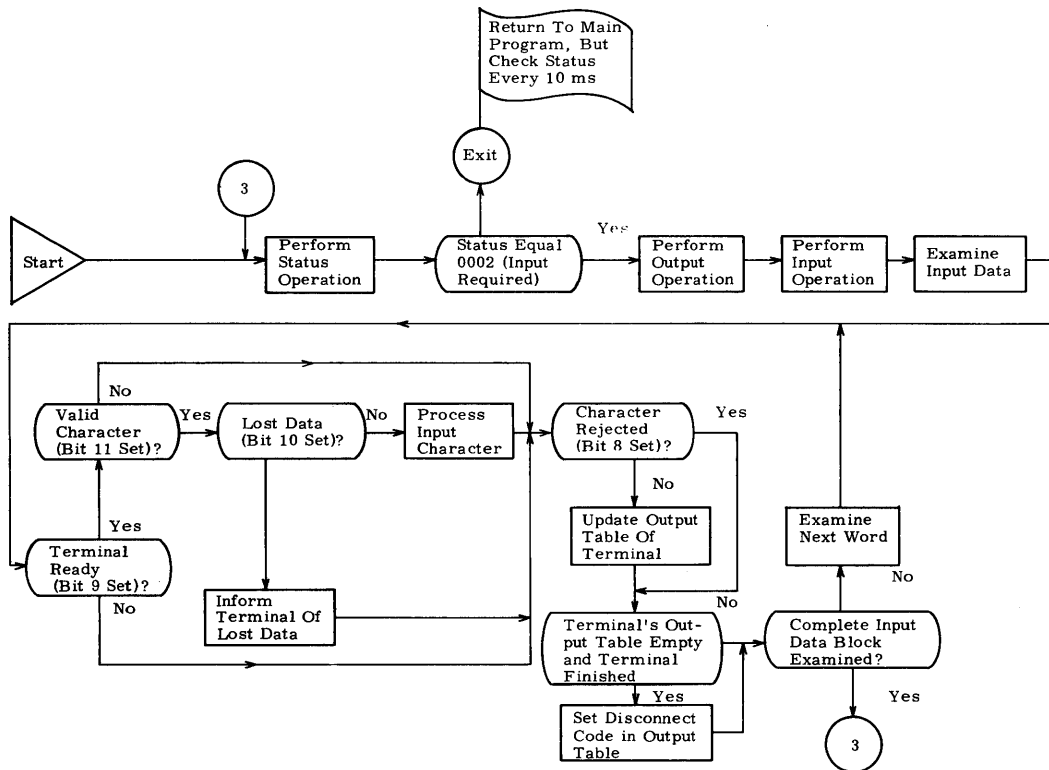

Figure 3-4. Sample Multiplexer Servicing Routine

## SYMBOL DATA

Table 3-3 contains the 8-level American Standard Code for Information Interchange (ASCII) character set. This character set is utilized by a 6676/8-level teletype-writer communications system.

TABLE 3-3. ASCII CHARACTER SET

Code	Code (Incl Odd Parity)	Character	Code	Code (Incl Odd Parity)	Character
000	200	NULL	035	235	S <sub>5</sub>
001	001	SOM	036	236	S <sub>6</sub>
002	002	EOA	037	037	S <sub>7</sub>
003	203	EOM	040	040	SPACE
004	004	EOT	041	241	!
005	205	WRU	042	242	" (quotes)
006	206	RU	043	043	#
007	007	BELL	044	244	\$
010	010	FE <sub>0</sub>	045	045	%
011	211	H. TAB	046	046	& (and)
012	212	LINE FEED	047	247	' (apostrophe)
013	013	V. TAB	050	250	(
014	214	FORM	051	051	)
015	015	RETURN	052	052	*
016	016	SO	053	253	+ (plus)
017	217	SI	054	054	, (comma)
020	020	DC <sub>0</sub>	055	255	- (hyphen)
021	221	X-ON	056	256	. (period)
022	222	TAPE <sup>AUX</sup> <sub>ON</sub>	057	057	/
023	023	X-OFF	060	260	0 (zero)
024	224	TAPE <sup>AUX</sup> <sub>OFF</sub>	061	061	1 (one)
025	025	ERROR	062	062	2
026	026	SYNC	063	263	3
027	227	LEM	064	064	4
030	230	S <sub>0</sub>	065	265	5
031	031	S <sub>1</sub>	066	266	6
032	032	S <sub>2</sub>	067	067	7
033	233	S <sub>3</sub>	070	070	8
034	034	S <sub>4</sub>	071	271	9
072	272	: (colon)	120	320	P
073	073	; (semicolon)	121	121	Q
074	274	<	122	122	R
075	075	= (equal)	123	323	S
076	076	>	124	124	T
077	277	?	125	325	U
100	100	@	126	326	V

TABLE 3-3. (Cont'd)

Code	Code (Incl Odd Parity)	Character	Code	Code (Incl Odd Parity)	Character
101	301	A	127	127	W
102	302	B	130	130	X
103	103	C	131	331	Y
104	304	D	132	332	Z
105	105	E	133	133	[
106	106	F	134	334	\
107	307	G	135	135	]
110	310	H	136	136	↑
111	111	I	137	337	←
112	112	J	140	Not Used	
113	313	K	↓		
114	114	L	173		
115	315	M	174	174	ACK
116	316	N	175	375	ALT. MODE
117	117	O	176	376	ESC
			177	177	RUB OUT

Loading the codes as they appear in the ASCII Table will generate erroneous data to a teletypewriter. To output these codes, it is necessary to load modified codes into the Output Table of the program. The ASCII codes can be modified by performing an end-around left shift of the lower 8 bits of the table (see the example below). The highest order ( $2^8$ ) bit is discarded.

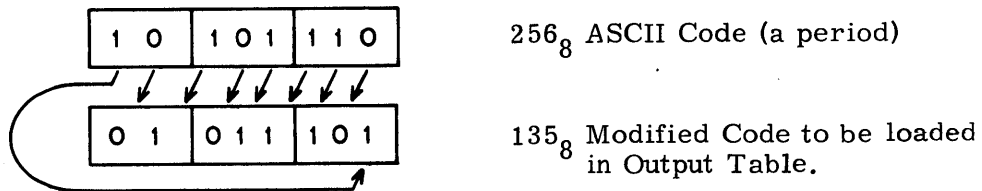

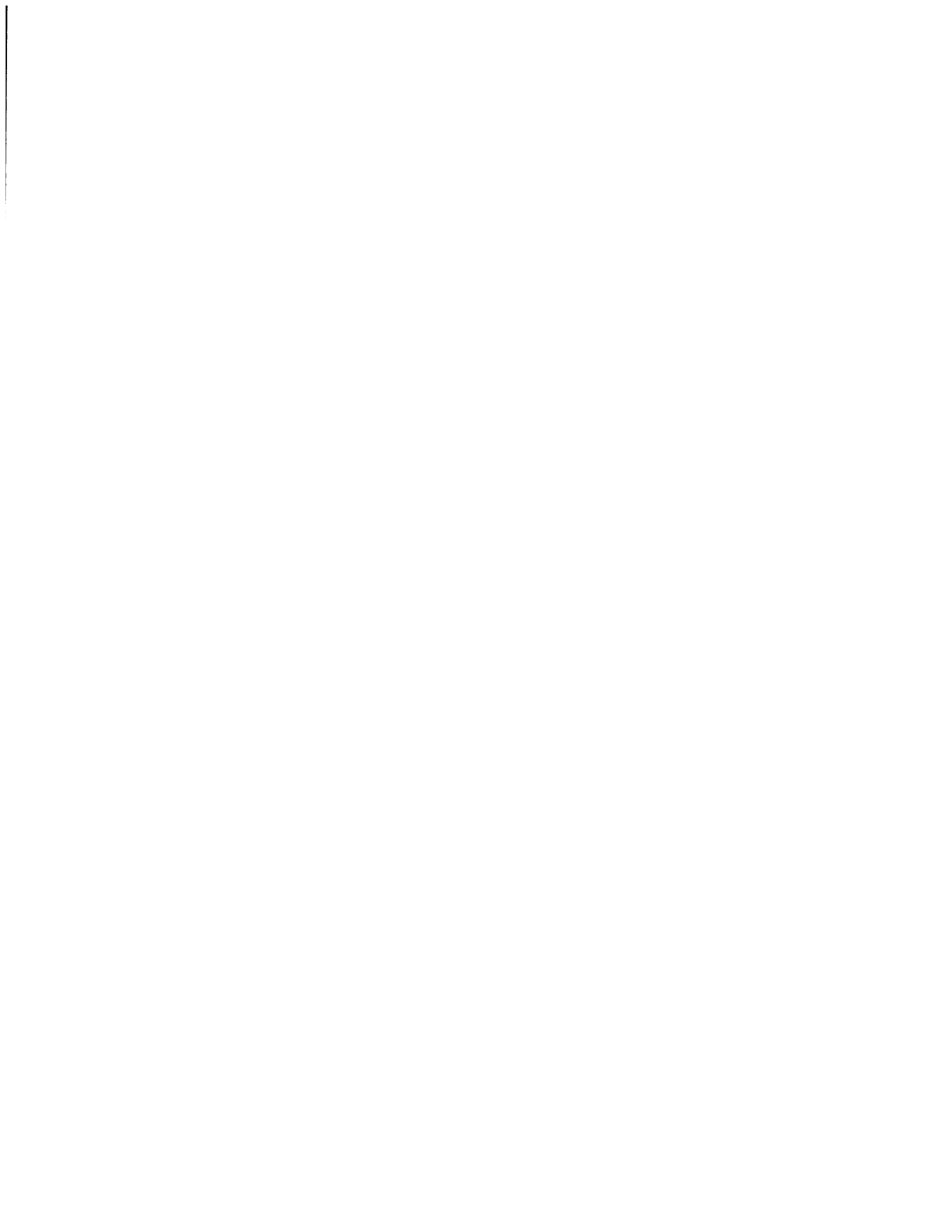

## SECTION 4

# OPTIONAL INTERFACE INFORMATION

This section provides operating and programming information for optional Dual Access Interface.

### DESCRIPTION AND OPERATION

The description and operation of the dual access multiplexer is the same as the single access multiplexer described in Section 2 of this manual. However, the dual access multiplexer contains another control panel (Equipment Select switches and Select Status, Select Input, and Select Output indicators for both channels installed) (See Figure 2-2.) Figure 4-1 illustrates a 6676 plus its modem (DATA PHONE Data Set 103) interfacing ASR-33 Teletypes to two 6000 computer systems via the optional dual channel interface.

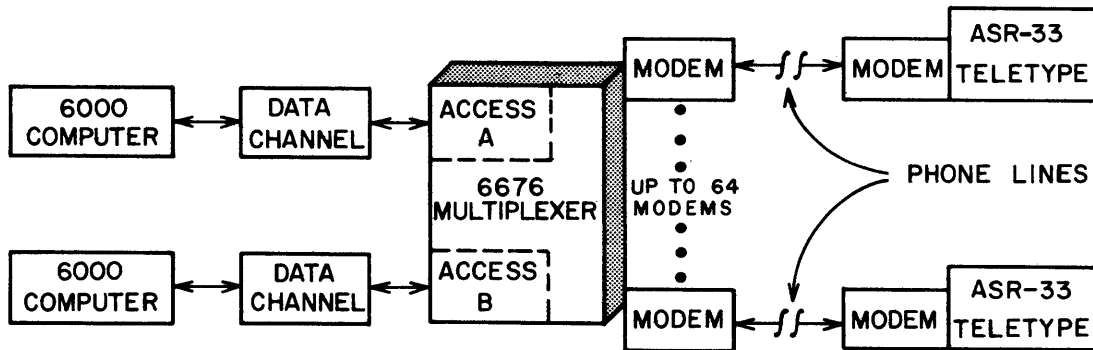

Figure 4-1. 6000/Dual Channel 6676 Relationship

### PROGRAMMING

#### FUNCTION SELECT CODES

Table 4-1 contains the dual access multiplexer function select codes. The X prefix of each function code must compare with one of the Equipment Select switch settings.

TABLE 4-1. DUAL ACCESS MULTIPLEXER FUNCTION CODES

Octal Codes	Description
X001	Select Output
X002	Select Status Request
X003	Select Input
X004	Select Reservation

Select Output, Status Request, and Input

These function codes are detailed in Section 3 of this manual. Select Output and Select Input can be performed only on the reserved channel. Select Status may be performed by the unreserved channel as well as the reserved channel.

Select Reservation

Receipt of a Select Reservation function code (X004), connects the multiplexer to the data channel issuing the function code. This reservation function code must precede an input or output function code. This code clears all previous function codes, including a reservation made by another data channel. The multiplexer accepts Request Status function codes from either data channels even though the multiplexer is reserved. The use of the Select Reservation function code may result in the loss of some data without setting the associated Lost Data status bit.

STATUS

Figure 4-2 is the status response format for a dual access multiplexer.

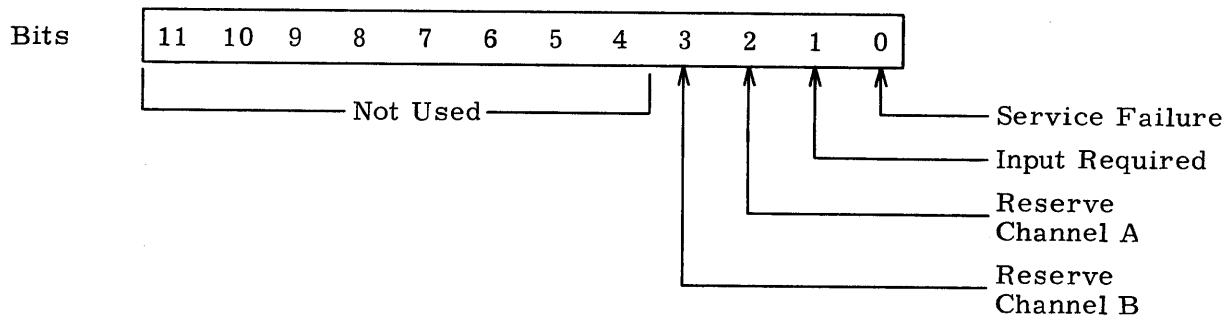

Figure 4-2. Dual Access Multiplexer Status Response Word

Service Failure and Input Required

These status bits are detailed in Section 3 of this manual.

Reserve Channel A

The multiplexer is reserved by peripheral processor A. This status bit clears only when peripheral processor B issues a Select Reservation function code.

Reserve Channel B

The multiplexer is reserved by peripheral processor B. This status bit clears only when peripheral processor A issues a Select Reservation function code.





**CONTROL DATA**  
CORPORATION

SPECIAL SYSTEMS DIVISION

4201 North Lexington Avenue, St. Paul, Minnesota 55112